

TEST CASE DOCUMENTATION AND TESTING RESULTS

LSTC-QA-LS-DYNA-AWG-ERIF-1.1-17

TEST CASE ID AWG-ERIF-1.1

Ballistic Impact:

Ti 6-4 Projectile (solid elements) impacts
a 304L SS plate (shell elements)

Tested with LS-DYNA® R12.0 Revision 148708

Friday 11th December, 2020

Warranty Disclaimer:

The test case(s) described herein are for illustrative purposes only. LSTC does not warrant that a user of these or other LS-DYNA features will experience the same or similar results or that a feature will meet the user's particular requirements or operate error free. FURTHERMORE, THERE ARE NO WARRANTIES, EITHER EXPRESS OR IMPLIED, ORAL OR WRITTEN, WITH RESPECT TO THE DOCUMENTATION AND SOFTWARE DESCRIBED HEREIN INCLUDING, BUT NOT LIMITED TO ANY IMPLIED WARRANTIES (i) OF MERCHANTABILITY, OR (ii) FITNESS FOR A PARTICULAR PURPOSES, OR (iii) ARISING FROM COURSE OF PERFORMANCE OR DEALING, OR FROM USAGE OF TRADE OR. THE REMEDIES SET FORTH HEREIN ARE EXCLUSIVE AND IN LIEU OF ALL OTHER REMEDIES FOR BREACH OF WARRANTY.

Document Information

Confidentiality	external use
Document Identifier	LSTC-QA-LS-DYNA-AWG-ERIF-1.1-17
Author(s)	Prepared by LS-DYNA® Aerospace Working Group
Number of pages	66
Date created	Friday 11 th December, 2020
Distribution	LS-DYNA® Aerospace Working Group / internal LSTC QA

Contents

1 Introduction	1
1.1 Purpose of this Document	1
2 Test Case Information	2
3 Test Case Specification	3
3.1 Test Case Purpose	3
3.2 Test Case Description	4
3.3 Model Description	6
4 Test Specifications	8
4.1 Test Case Targets	8
4.2 Pass/Fail Criteria	9
5 Test Case Results	11
5.1 Software and Hardware Specifications	11
5.2 Results Summary	12
5.3 Result Details	13
5.3.1 Test Target 1 (input deck with 105% of the ballistic limit)	14
5.3.2 Test Target 1 (input deck with 95% of the ballistic limit)	27
5.3.3 Test Target 2 (input deck with 105% of the ballistic limit)	40
5.3.4 Test Target 2 (input deck with 95% of the ballistic limit)	53
References	66

1 Introduction

1.1 Purpose of this Document

This document specifies the test case AWG-ERIF-1.1. It provides general test case information like name and ID as well as information to the confidentiality, status, and classification of the test case.

A detailed description of the test case is given, the purpose of the test case is defined, and the tested features are named. The test case specifications also state the target measures for testing and the expected results, as well as their pass and fail criteria.

Testing results are provided in section 5 for the therein mentioned LS-DYNA® version and platforms.

2 Test Case Information

Test Case Summary	
Confidentiality	external use
Test Case Name	Ballistic Impact: Ti 6-4 Projectile (solid elements) impacts a 304L SS plate (shell elements)
Test Case ID	AWG-ERIF-1.1
Test Case Status	active
Test Case Classification	Validation
Test Case Source	NASA Glenn Research Center
Tested Keyword	*CONTROL_SHELL BWC=1,2 PROJ=0,1 *MAT_024 (PIECEWISE_LINEAR_PLASTICITY) VP=0,1 *MAT_015 (JOHNSON_COOK) VP=0,1 *MAT_081 (PLASTICITY_WITH_DAMAGE) *MAT_123 (MODIFIED_PIECEWISE_LINEAR_PLASTICITY) VP=0,1
Member of Test Suite	AWG ERIF SUITE
Metadata	AWG ERIF

Table 1: Test Case Summary

3 Test Case Specification

3.1 Test Case Purpose

The purpose of Test Case ID AWG-ERIF-1.1 is the validation of an impact experiment performed at NASA Glenn Research Center. The reliability and consistency of LS-DYNA® as a finite element solver for this impact simulation is evaluated by performing analyses with various material models, element formulations/options, contact algorithm options, and hourglass algorithms (see table 4).

3.2 Test Case Description

This Test Case contains a ballistic impact of a Ti 6-4 projectile on a 304L SS plate (see figure 1). An experiment with a 7"x7"x0.04" 304L SS steel plate was chosen as the model geometry and material specification. The ballistic limit was determined by the experimental results (see figure 2).

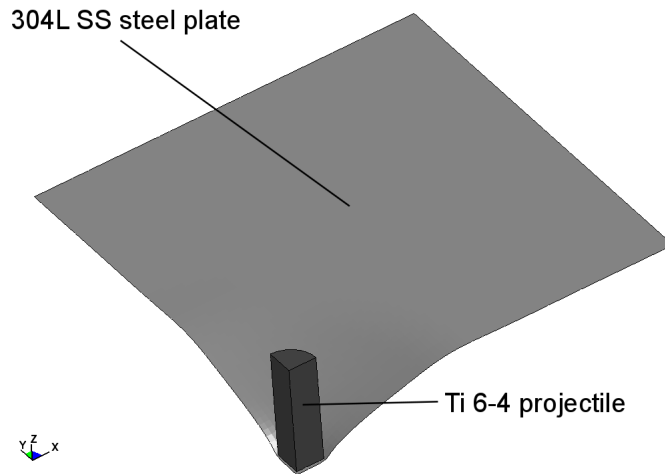

Figure 1: Model: Ballistic Impact - Ti 6-4 Projectile impacts a 304L SS plate

The experiment is modelled via a lagrangian approach with shell elements for the steel plate and solid elements for the projectile. A summary of the experimental set-up can be found in table 2.

Physical Model Information	
plate geometry	7"x7"x0.04"
plate material	304L SS steel
projectile geometry	length = 1" , radius = 0.25"
projectile material	Ti 6-4
projectile velocity (ballistic limit see figure 2)	635 ft/s

Table 2: Experimental set-up data

The ballistic limit for a variety of impact experiments was provided by NASA Glenn Research Center (see figure 2).

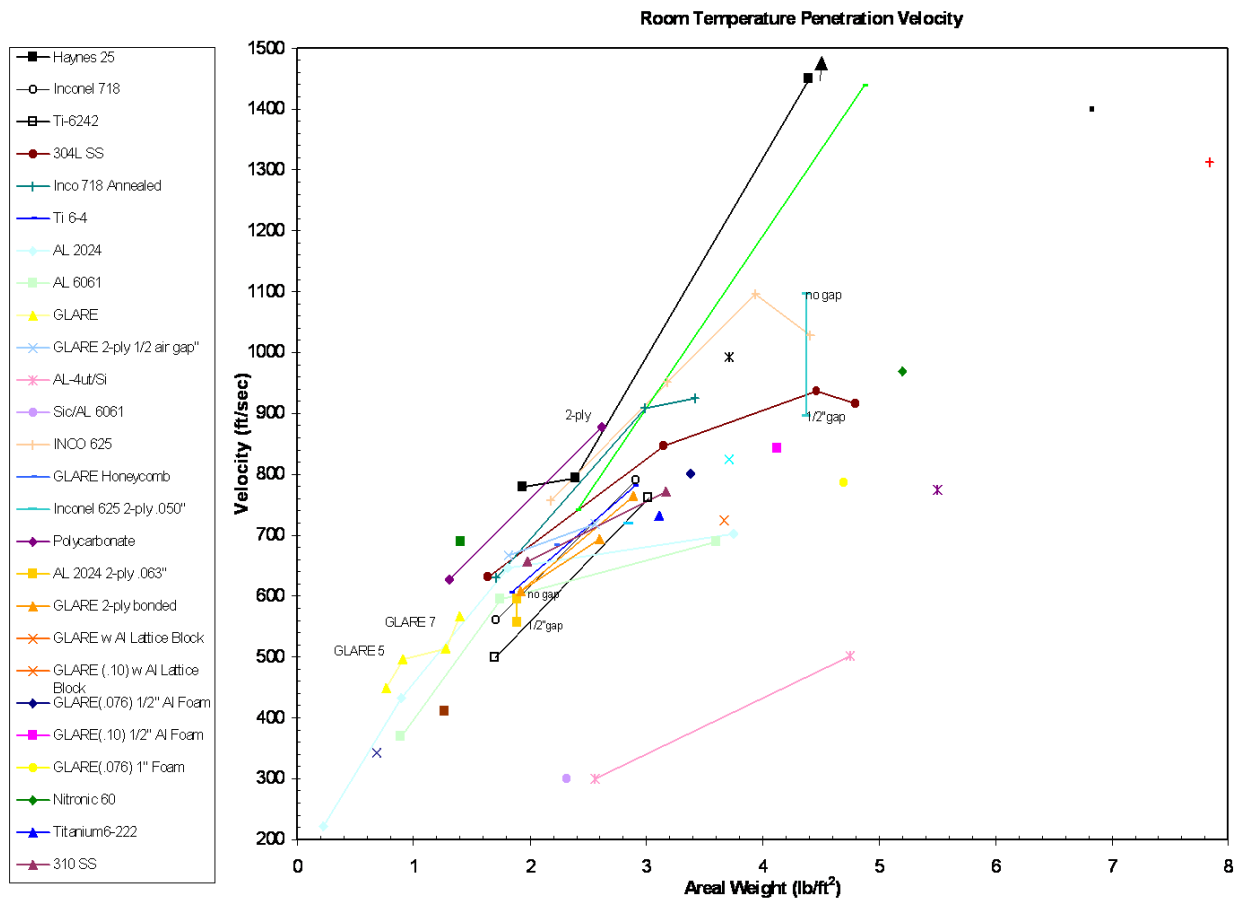

Figure 2: Experimental results: ballistic limit of various impact tests

3.3 Model Description

The model geometry is discretized with solid elements for the projectile and shell elements for the steel plate. See table 3 for the number of elements and material specifications for the model. Due to symmetry conditions, a quarter model of the actual geometry is used (see figure 3). Symmetry boundary conditions are applied on the symmetry plane and the outer edges of the steel plate are simply supported. The projectile has an initial z velocity defined on all nodes and is guided along the z axis by boundary conditions applied in the x and y direction on the symmetry plane.

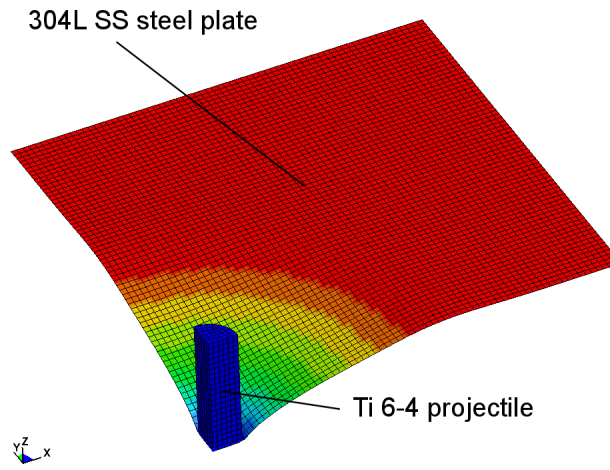

Figure 3: FEA model: Ballistic Impact - Ti 6-4 Projectile impacts a 304L SS plate

Model information	
Nodes	5944
Solid elements	640
Solid materials	1
Shell elements	4900
Shell materials	1
Parts	2
Units	in (length), s (time), lbf-s ² /in (mass), psi (stress), lbf-in (energy)

Table 3: FEA Model Information

Fourteen variations (called sub test cases) of the model are set up with different shell element formulations for the steel plate (parameter ELFORM), different warping stiffnesses in the element formulation (parameters BWC and PROJ), different material algorithms for the material behaviour, different contact algorithm options (parameter SOFT), and different approaches to hourglass stabilization (parameter IHQ). A summary of these fourteen sub test cases and the specific values for the parameters in each sub test case can be found in table 4.

For each of the 14 sub test cases, two simulations are performed to verify that the ballistic limit from the simulations is consistent with the experiment. The initial velocity of the projectile is defined to be 95% and 105% of the ballistic

limit. Models with an initial velocity of 95% of the ballistic limit should not penetrate the steel plate and models with an initial velocity of 105% of the ballistic limit should penetrate the steel plate.

The material definitions and their parameters can be found in the input decks and were provided by NASA Glenn Research Center.

Sub Test ID	ELFORM ¹	BWC ²	PROJ ³	MATERIAL ⁴	SOFT ⁵	IHQ ⁶
1	2	2	-	MAT_024	0	1-3
2	1	-	-	MAT_024	0	1-3
3	2	1	0	MAT_024	0	1-3
4	2	1	1	MAT_024	0	1-3
5	16	-	-	MAT_024	0	4-6
6	2	2	-	MAT_024	0	4-6
7	1	-	-	MAT_024	0	8
8	16	-	-	MAT_024	0	1-3
9	2	2	-	MAT_015	0	1-3
10	2	2	-	MAT_058	0	1-3
11	2	2	-	MAT_081	0	1-3
12	2	2	-	MAT_024	1	1-3
13	2	2	-	MAT_081	0	1-3
14	2	2	-	MAT_024	0	1-3

¹ Parameter ELFORM in *SECTION.SHELL keyword

² Parameter BWC in *CONTROL.SHELL keyword

³ Parameter PROJ in *CONTROL.SHELL keyword

⁴ MATERIAL is related to the LS-DYNA material number

⁵ Parameter SOFT in *CONTACT_AUTOMATIC_NODES_TO_SURFACE keyword

⁶ Parameter IHQ in *HOURLASS keyword

Table 4: Specification of sub test cases

The test case contains a total of 28 input decks, derived from the 14 sub test cases times 2 velocity definitions of 95% and 105% of the ballistic limit, respectively.

The input files names have the following format:

- **1.1.sub test ID.k** for the sub test cases with a projectile velocity of 95% of the ballistic limit
- **1.1.sub test ID.h.k** for the sub test cases with a projectile velocity of 105% of the ballistic limit

Herein the leading '1.1.' refers to the test case number, the 'sub test ID' refers to the specific combination of variable parameters in table 4 and the suffix 'h' refers to the velocity of the projectile to set to 105% of the ballistic limit.

4 Test Specifications

4.1 Test Case Targets

Table 5 displays the test case targets. The test case targets specify values or a series of values taken from the finite element analysis solution of the test case and they are used in a comparison of analysis results and experimental data. They are chosen in a way that they can be directly or indirectly compared to the experimentally determined values or observations.

Test Case Targets				
Target number	output	component type	component id	retrieved from
1	z-displacement	node	1	binout/nodout file
2	kinetic energy	part	2	binout/matsum file

Table 5: Test Case targets for Test Case ID AWG-ERIF-1.1

The target values are chosen to identify whether the projectile penetrates the plate or is stopped by the plate. Target number 1 is the displacement of the center node of the plate in the direction of the projectile. Target number 2 is the kinetic energy of the projectile. The targets are used to evaluate the perforation of the steel plate (see section 4.2).

4.2 Pass/Fail Criteria

These are the Pass/Fail criteria used for the Validation of the Test Case ID AWG-ERIF-1.1.

The sub test case passes if the test case target data falls within the corridor bounds. Otherwise the test fails.

The test case corridors are upper and lower bounds for the test case targets. They were defined based on the test target data obtained with LS-DYNA® R9.0 Revision 108899 binaries by the following process:

- For a specific test case target, interpolate the data from different platform and executable (R9.0 Revision 108899) combinations, so that the time domain is the same.
- Calculate the upper and lower bounds by:

$$bound_{up}(i) = max(i) + 0.2 \times [max(i) - min(i)] + 0.05 \times peak$$

$$bound_{low}(i) = min(i) - 0.2 \times [max(i) - min(i)] - 0.05 \times peak$$

where $max(i)$, $min(i)$ are the maximum and minimum values at the i_{th} time step across all platforms and executable (R9.0 Revision 108899) combinations the test case was calculated with, $peak$ is the maximum absolute y value across the whole time domain, $bound_{up}(i)$ and $bound_{low}(i)$ are the upper and lower bounds for the i_{th} time step.

- Adjust the upper and lower bounds if the upper bound at the last time step ($bound_{up}(end)$) exceed the upper limit ($limit_{up}$) or the lower bound at the last time step ($bound_{low}(end)$) is smaller than the lower limit ($limit_{low}$) by:

$$d_{end} = bound_{up}(end) - limit_{up}$$

$$d_i = d_{i+1} \times (i - 2) / i$$

$$bound_{up}^a(i) = bound_{up}(i) - d_i$$

$$d_{end} = limit_{low} - bound_{low}(end)$$

$$d_i = d_{i+1} \times (i - 2) / i$$

$$bound_{low}^a(i) = bound_{low}(i) + d_i$$

where $bound_{up}^a(i)$ and $bound_{low}^a(i)$ are the adjusted upper and lower bounds at the i_{th} time step, d_i is the adjusted distance of the bounds for the i_{th} time step, d_{end} is the adjusted distance of the bounds for the last time step, and $bound_{up}(end)$ and $bound_{low}(end)$ are the upper and lower bounds at the last time step before adjustment.

- Test case target 1 (z-displacement node 1) of sub test cases with 95% of the ballistic limit should not exceed 1 inch ($limit_{low} = -1inch$).
- Test case target 2 (kinetic energy part 2) of sub test cases with 95% of the ballistic limit should be less than 90 in-lb at the end of the analysis ($limit_{up} = 90in - lb$).
- Test case target 1 (z-displacement node 1) of sub test cases with 105% of the ballistic limit should exceeds 1 inch ($limit_{up} = -1inch$).
- The test case target 2 (kinetic energy part 2) of sub test cases with 105% of the ballistic limit should be greater than 90 in-lb at the end of the analysis ($limit_{low} = 90in - lb$).

- The results of the sub test case 9 with 95% of the ballistic limit, and the sub test cases 11, 12, and 14 with 105% of the ballistic limit from R9.0 failed, so the corridor bounds of the following cases are further adjusted based on the upper limits ($limit_{up}$) and lower limits ($limit_{low}$) given the above.
 - The sub test case 9 with 95% of the ballistic limit: test case target 1 (z-displacement node 1).
 - The sub test case 11 with 105% of the ballistic limit: test case target 1 (z-displacement node 1) and test case target 2 (kinetic energy part 2).
 - The sub test case 12 with 105% of the ballistic limit: test case target 2 (kinetic energy part 2).
 - The sub test case 14 with 105% of the ballistic limit: test case target 1 (z-displacement node 1) and test case target 2 (kinetic energy part 2).

5 Test Case Results

5.1 Software and Hardware Specifications

In order to ensure cross-platform consistency, the herein mentioned sub test cases are run on platforms specified in table 6 and the results are calculated with software versions defined in table 7.

Platform Name	Operating system	CPU type	MPI-Protocol	Number of cpu's ¹
mars	CentOS 6.5	Intel® Xeon® E5- 2640 @ 2.50GHz	Platform MPI 8.2.0.0	4
dinar3b	SUSE LES 11	AMD® Opteron ® 6276 @ 2300MHz	Platform MPI 8.2.0.0	4

¹ Number of cpu's used for calculation of the test case

Table 6: Used Platforms and CPU Type's

Product	Version	Release	Revision	Parallel type ¹	Precision ²	executable
LS-DYNA®	971	R12.0	148708	SMP	SP	ls971.148708.R12.0
LS-DYNA®	971	R12.0	148708	SMP	DP	ld971.148708.R12.0
LS-DYNA®	971	R12.0	148708	MPP	SP	mpp971.148708.R12.0
LS-DYNA®	971	R12.0	148708	MPP	DP	mpd971.148708.R12.0

¹ MPP = Massively Parallel Processing, SMP = Symmetric Multiprocessing

² SP = single precision, DP = double precision

Table 7: Tested LS-DYNA® version

5.2 Results Summary

Table 8 contains the results of the Test Case ID AWG-ERIF-1.1 completed with all combinations of software and hardware defined in section 5.1 (14 * 2 * 3 * 4 - 3 total cases).

Details on the test results can be found in the section 5.3.

The table 8 validation summary is:

- **PASS** - Pass criteria in section 4.2 is attained.
- **FAILED** - Pass criteria in section 4.2 is not attained.
- **ERROR** - sub test case terminates due to error.
- **N/A** - sub test case was not calculated.

Sub Test ID	95% ballistic limit	105% ballistic limit
1	PASS	PASS
2	PASS	PASS
3	PASS	PASS
4	PASS	PASS
5	PASS	PASS
6	PASS	PASS
7	PASS	PASS
8	PASS	PASS
9	FAILED	PASS
10	N/A	N/A
11	PASS	FAILED
12	PASS	FAILED
13	PASS	PASS
14	PASS	FAILED

Table 8: Validation results summary for Test Case ID AWG-ERIF-1.1

5.3 Result Details

The following subsections contain detailed results for the Test Case ID AWG-ERIF-1.1 for LS-DYNA® R12.0 Revision 148708.

For each sub test case defined in section 3.3 there is a graph displaying the time history of the result target defined in section 4.1 for the platform and software version combinations defined in section 5.1.

The title of the graph states the test case ID and the name of input deck. The legend contains the result file name, output, platform, executable and number of cpu's separated by comma. A minus sign before the number of cpu's refers to the compatibility option for SMP calculations (see [1] for details on this option).

Example for title and legend:

Title:

'AWG_ERIF_TEST_CASE_1_1: 1.1.1.h.k' states the test case ID 1_1 and name of the input deck for sub test case 1 run at 105% of the ballistic limit.

Legend:

'glstat_internal_energy,ham,ls971.148708.R12.0,4' states that the graph shows the internal energy derived from the 'glstat' output file for an input deck which was calculated on the 'ham' platform with a LS-DYNA® R12.0 Revision 148708 binary (SMP, single precision) on four processors.

5.3.1 Test Target 1 (input deck with 105% of the ballistic limit)

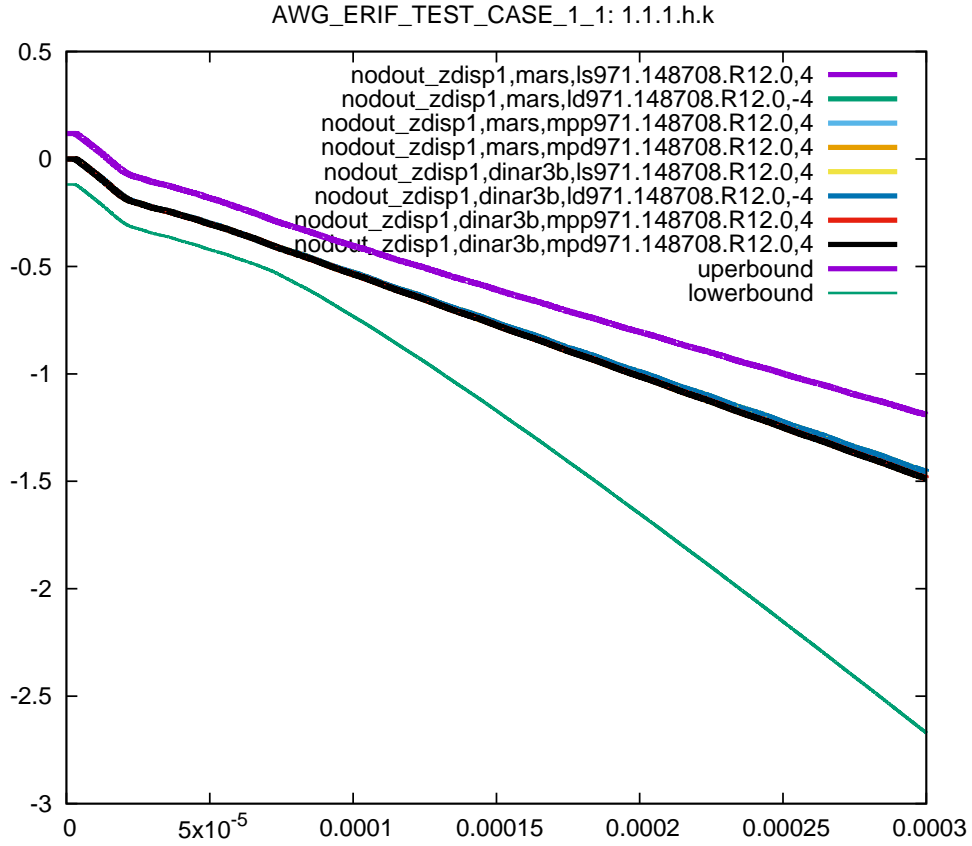

Figure 4: Cross platform results, nodal z displacement node 1, sub test case ID 1, 105% ballistic limit

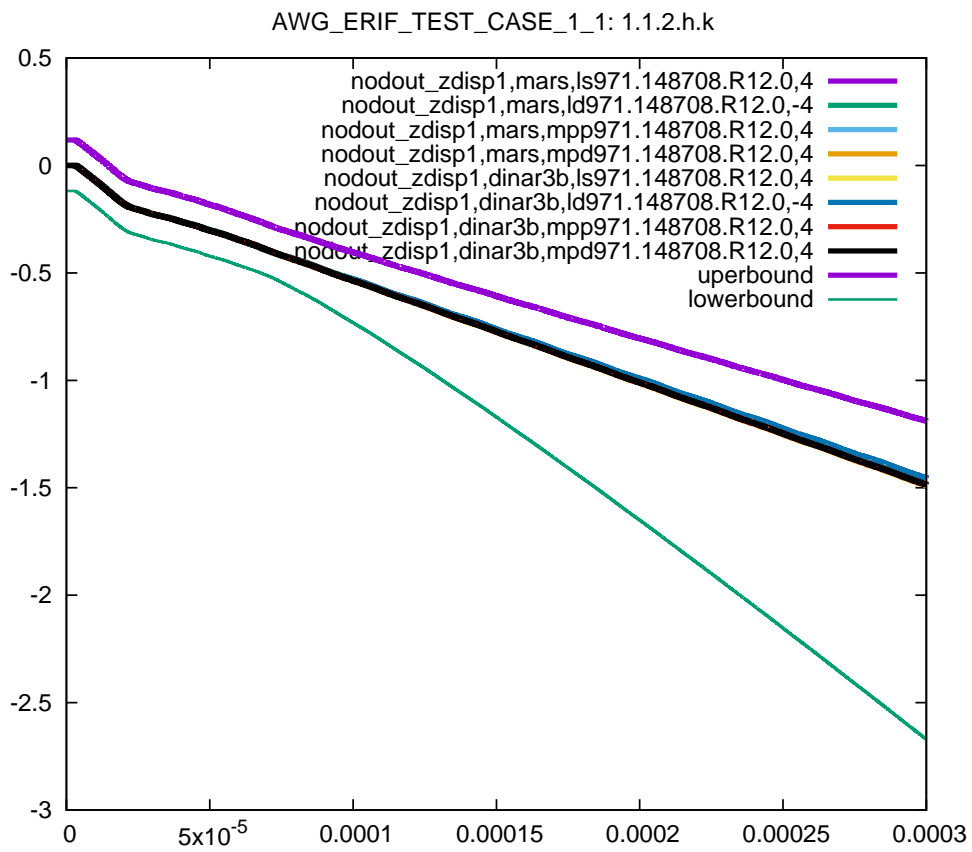

Figure 5: Cross platform results, nodal z displacement node 1, sub test case ID 2, 105% ballistic limit

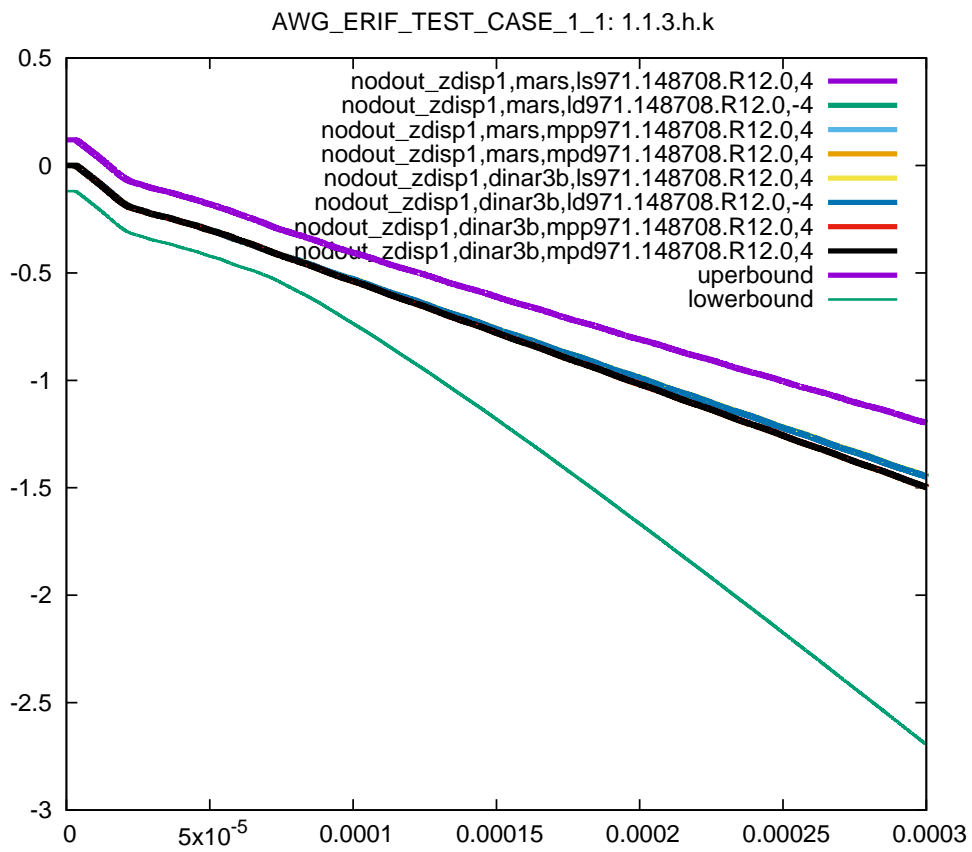

Figure 6: Cross platform results, nodal z displacement node 1, sub test case ID 3, 105% ballistic limit

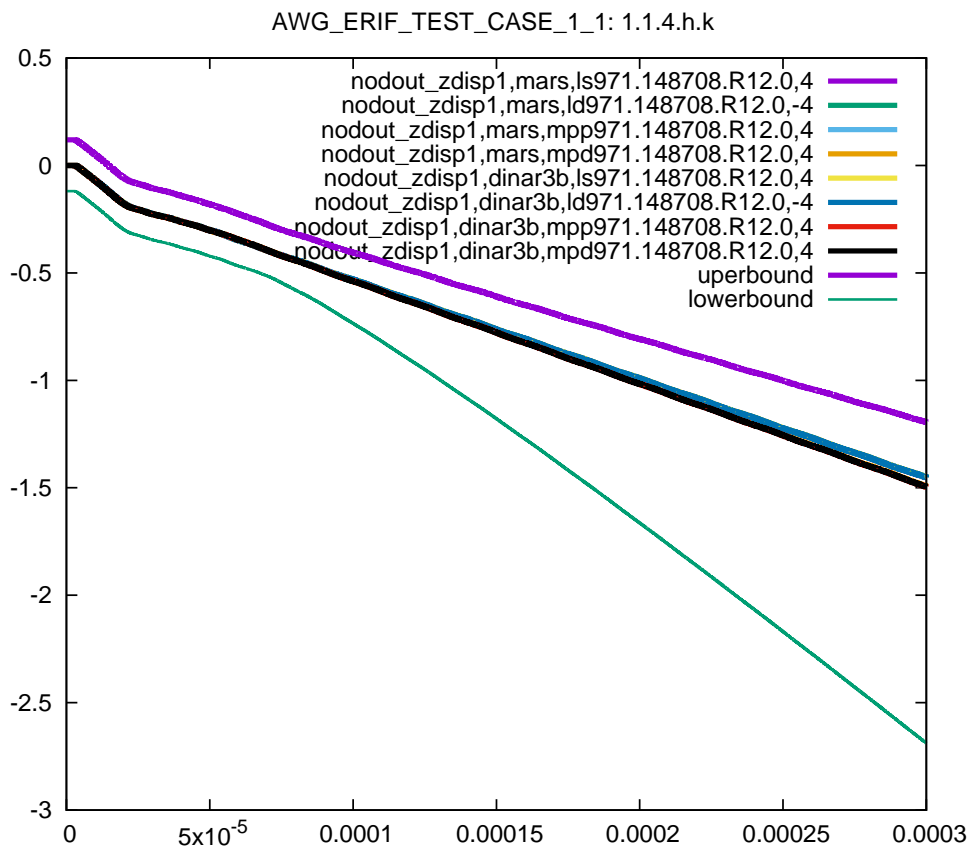

Figure 7: Cross platform results, nodal z displacement node 1, sub test case ID 4, 105% ballistic limit

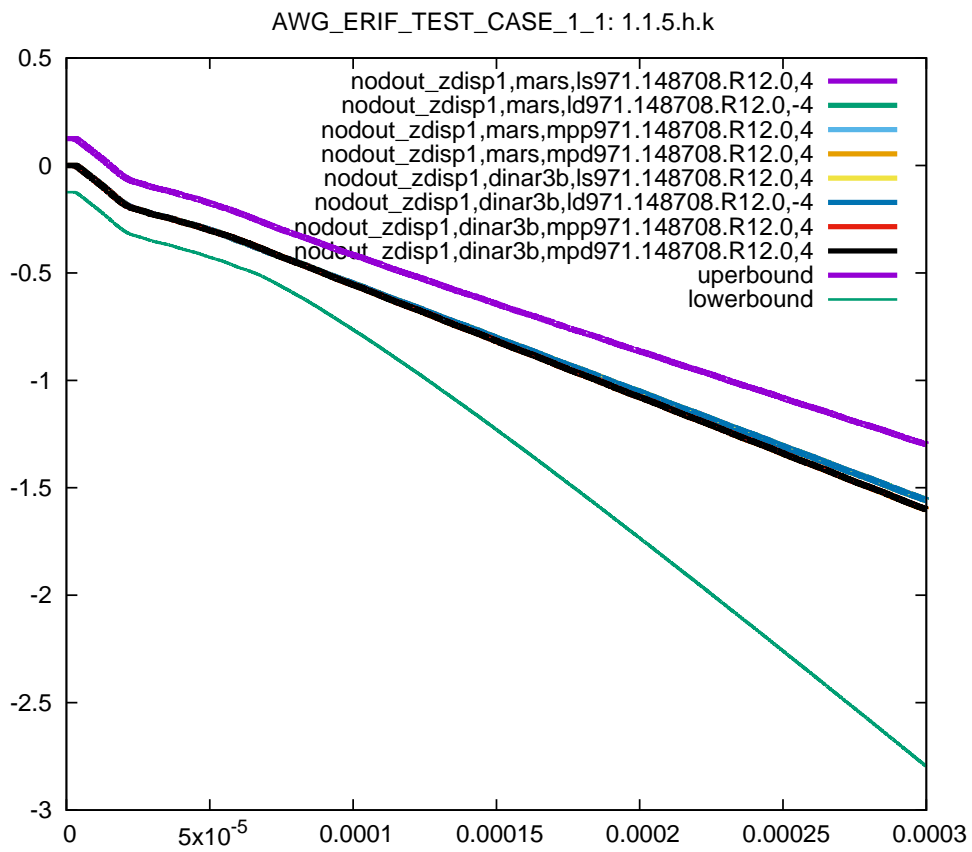

Figure 8: Cross platform results, nodal z displacement node 1, sub test case ID 5, 105% ballistic limit

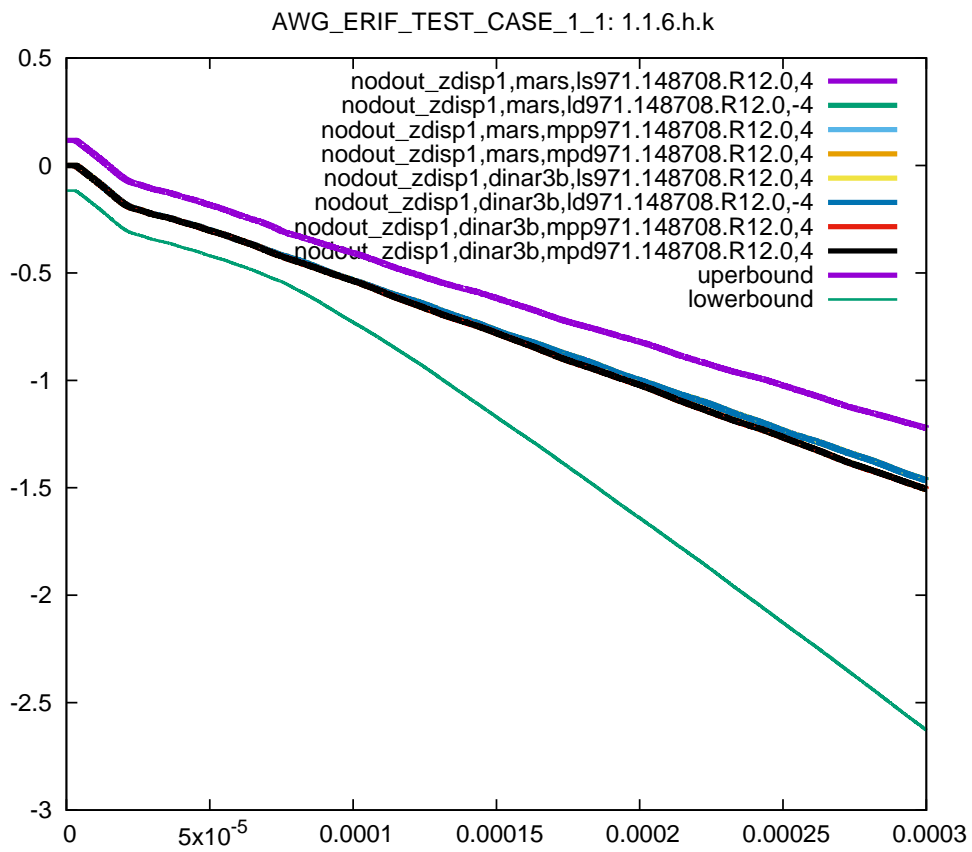

Figure 9: Cross platform results, nodal z displacement node 1, sub test case ID 6, 105% ballistic limit

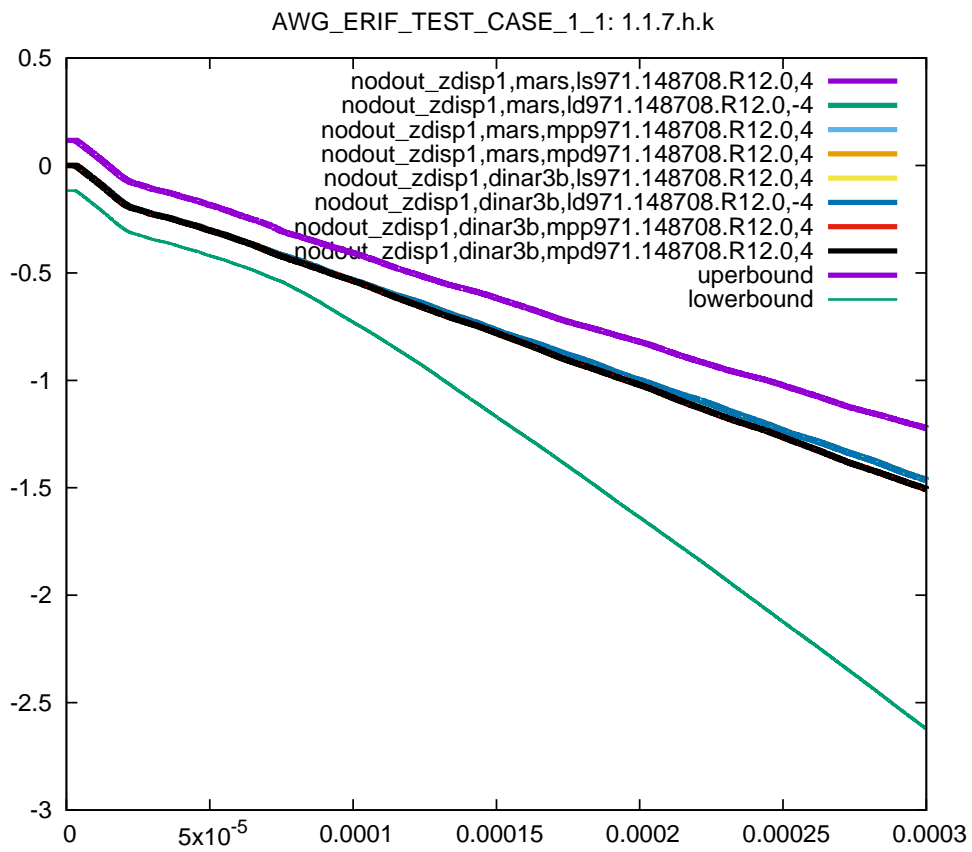

Figure 10: Cross platform results, nodal z displacement node 1, sub test case ID 7, 105% ballistic limit

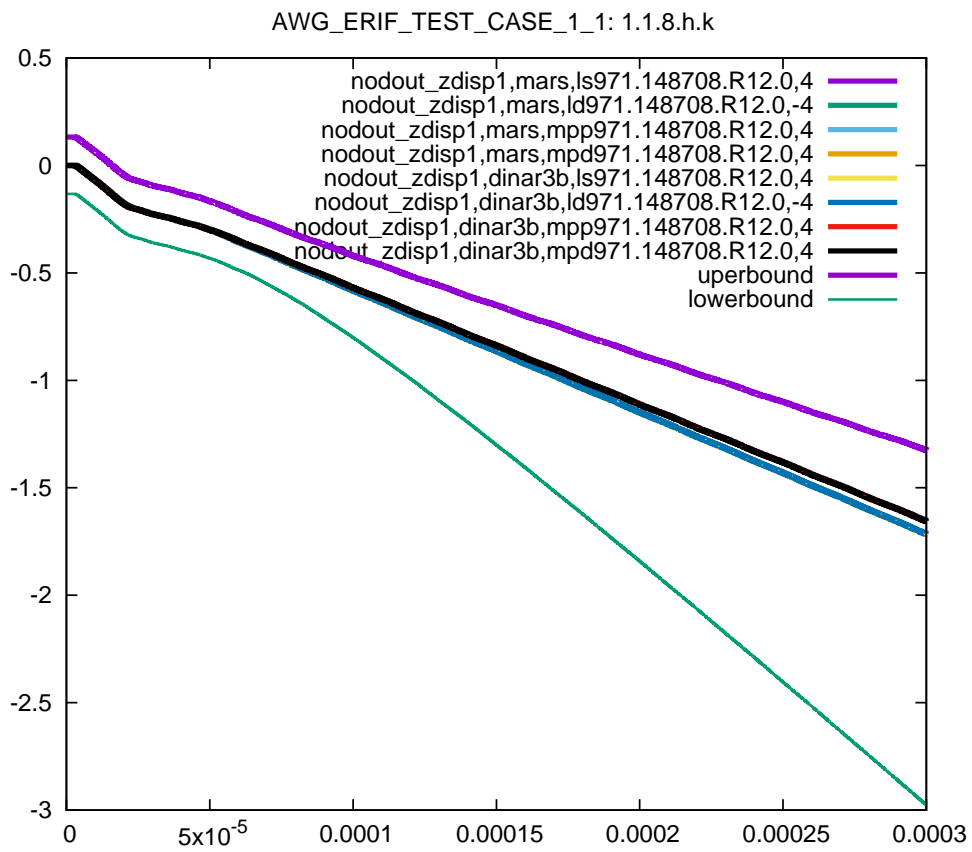

Figure 11: Cross platform results, nodal z displacement node 1, sub test case ID 8, 105% ballistic limit

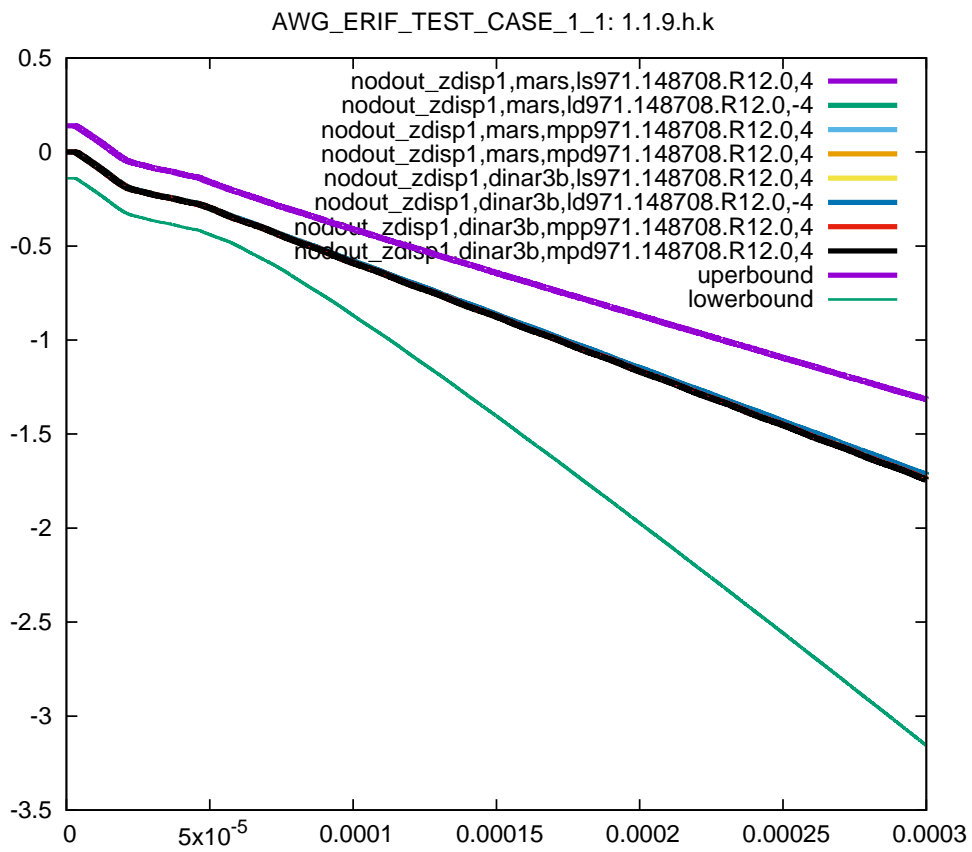

Figure 12: Cross platform results, nodal z displacement node 1, sub test case ID 9, 105% ballistic limit

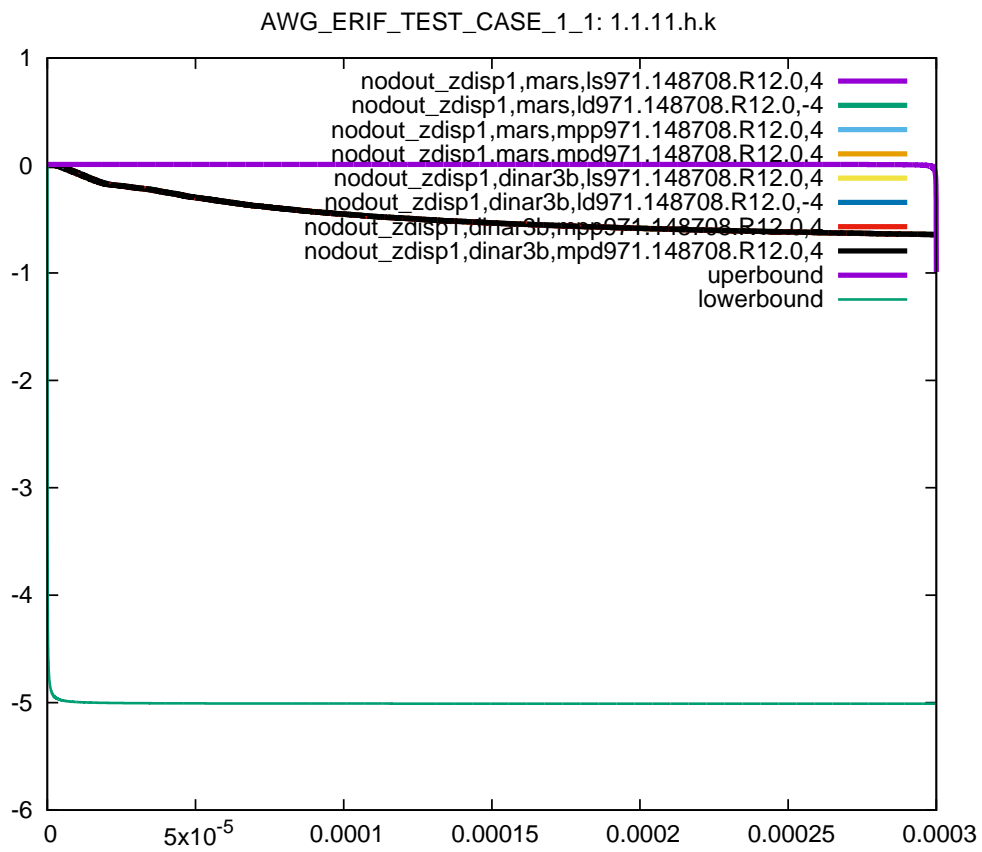

Figure 13: Cross platform results, nodal z displacement node 1, sub test case ID 11, 105% ballistic limit

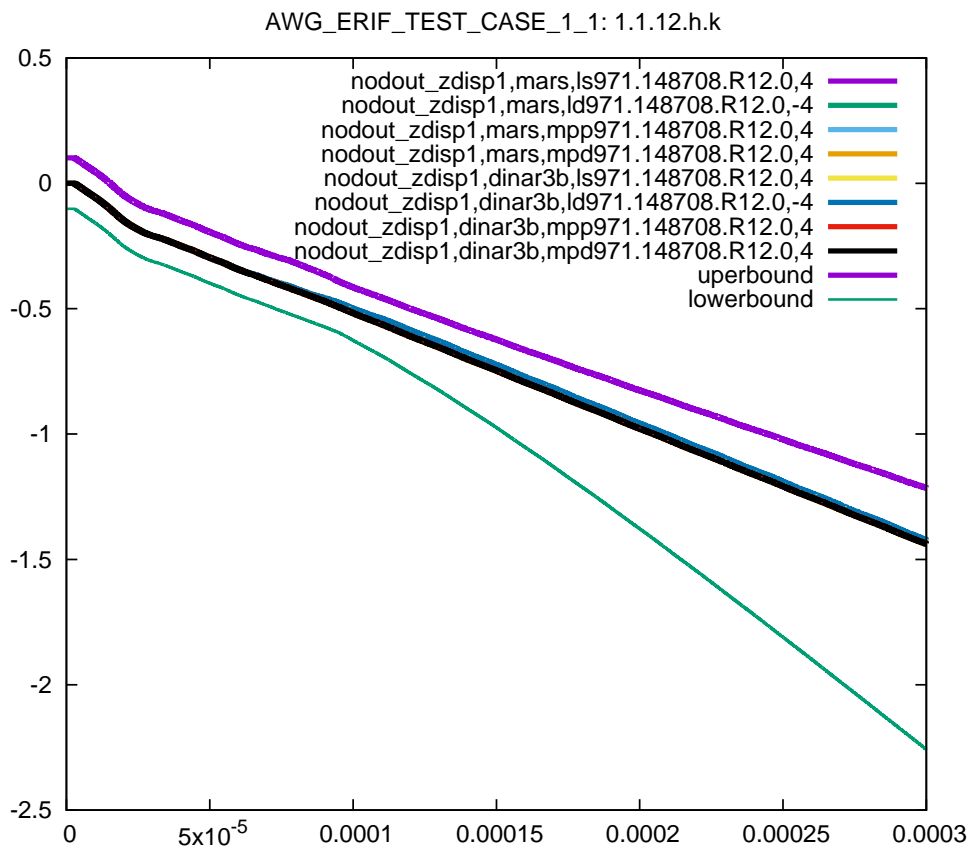

Figure 14: Cross platform results, nodal z displacement node 1, sub test case ID 12, 105% ballistic limit

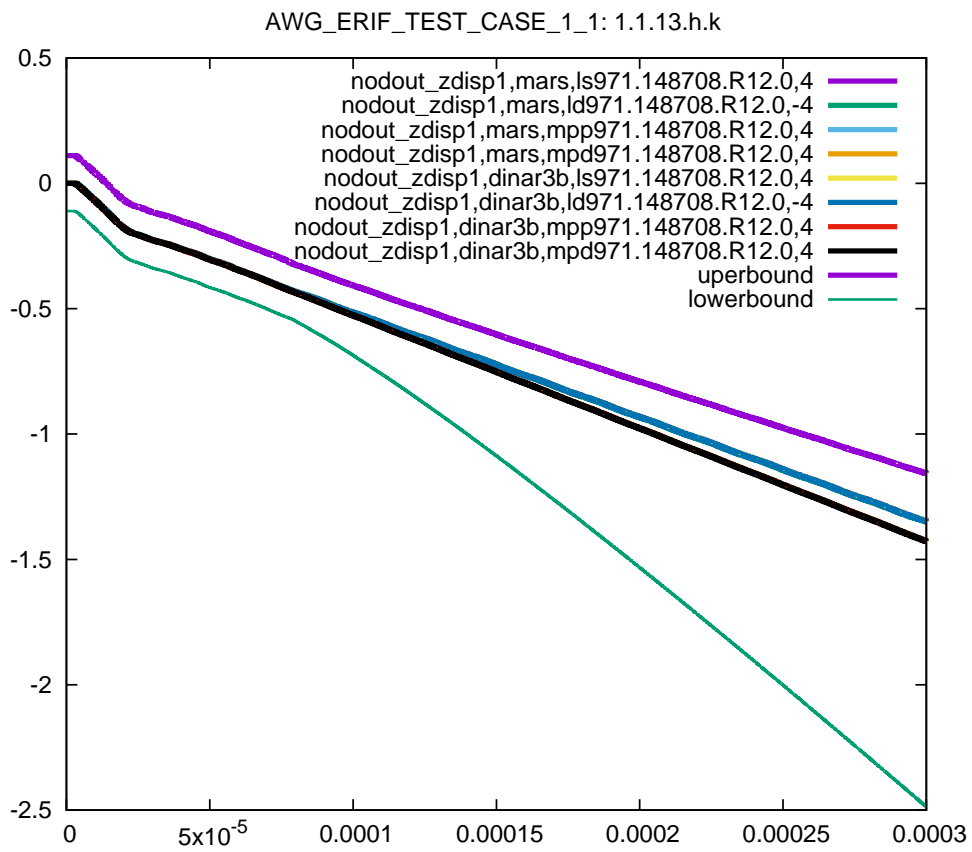

Figure 15: Cross platform results, nodal z displacement node 1, sub test case ID 13, 105% ballistic limit

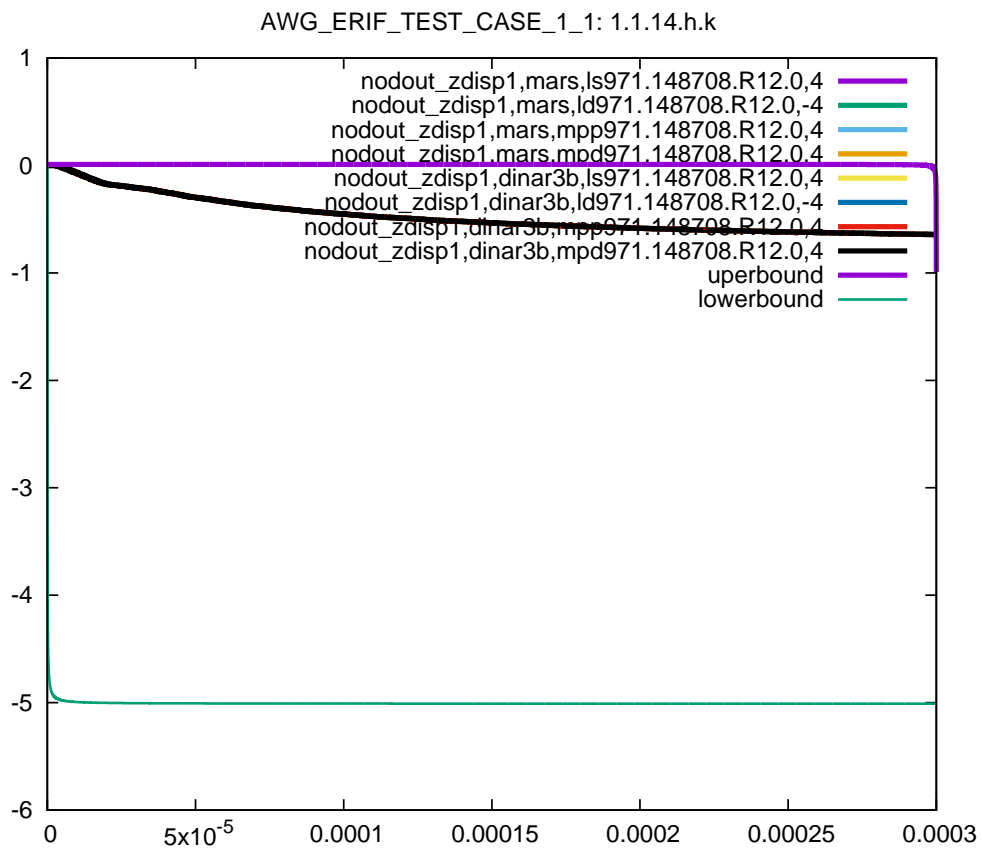

Figure 16: Cross platform results, nodal z displacement node 1, sub test case ID 14, 105% ballistic limit

5.3.2 Test Target 1 (input deck with 95% of the ballistic limit)

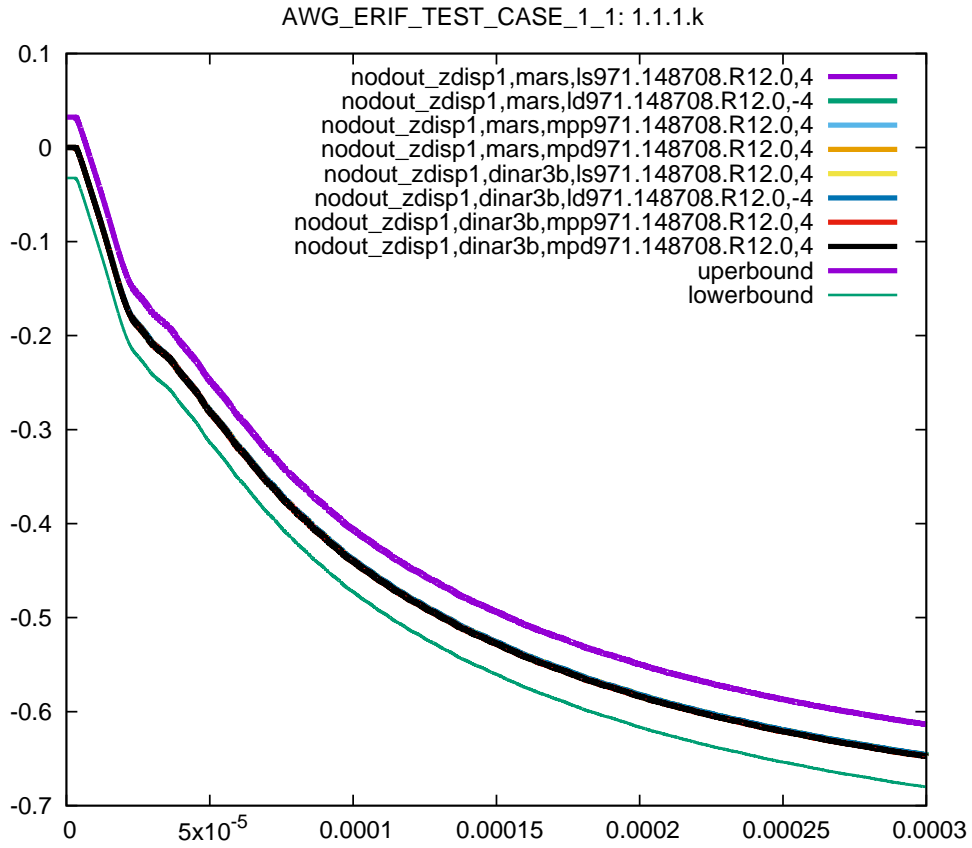

Figure 17: Cross platform results, nodal z displacement node 1, sub test case ID 1, 95% ballistic limit

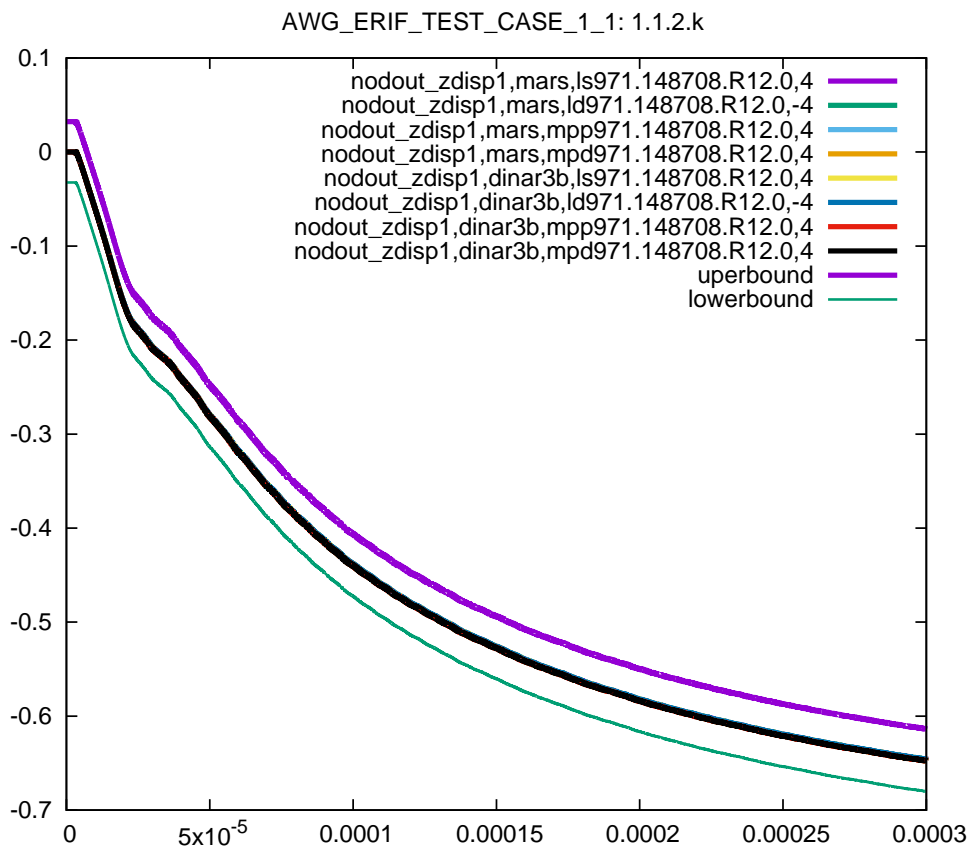

Figure 18: Cross platform results, nodal z displacement node 1, sub test case ID 2, 95% ballistic limit

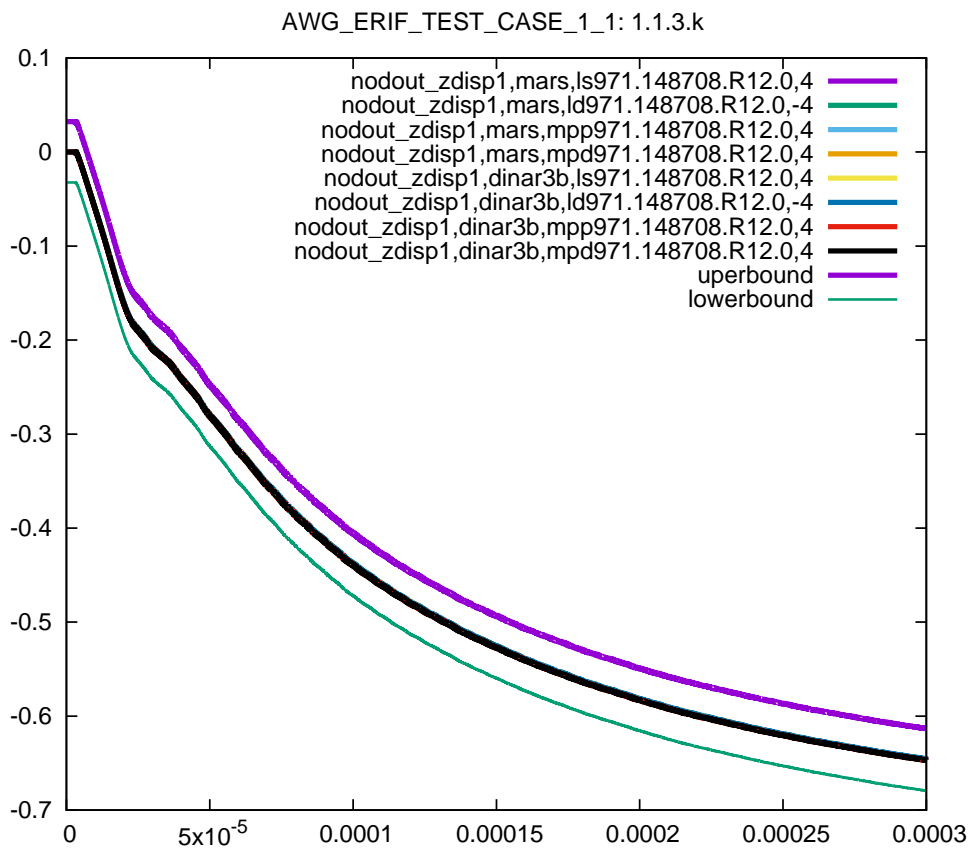

Figure 19: Cross platform results, nodal z displacement node 1, sub test case ID 3, 95% ballistic limit

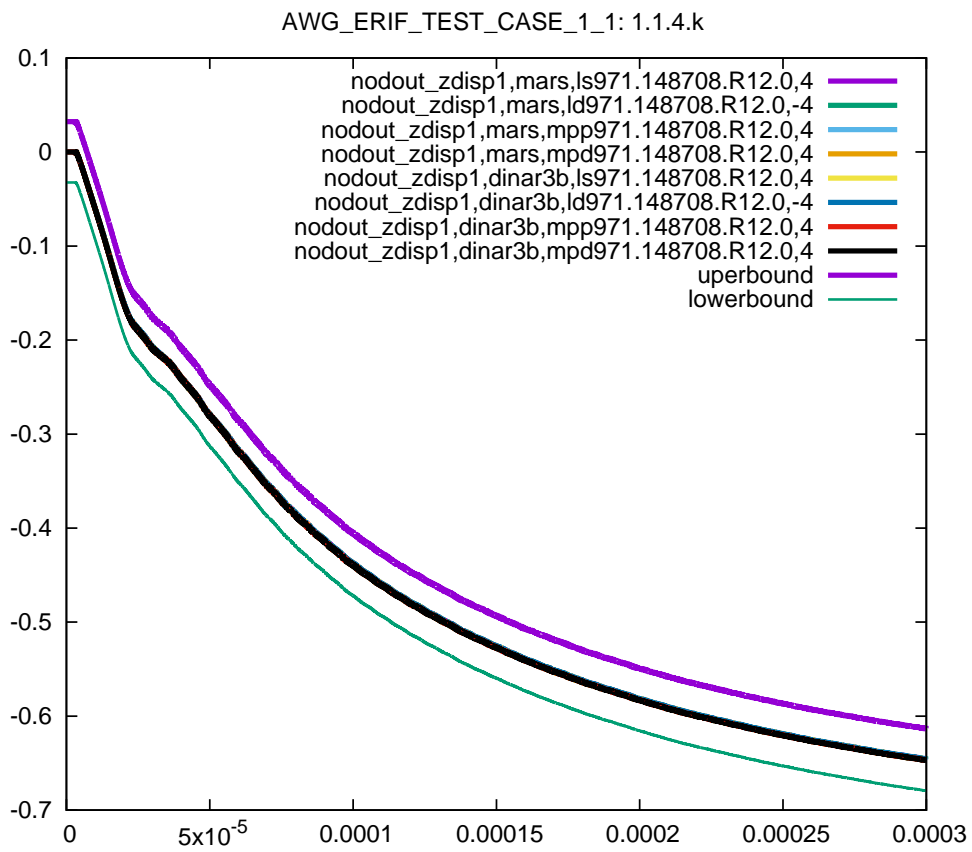

Figure 20: Cross platform results, nodal z displacement node 1, sub test case ID 4, 95% ballistic limit

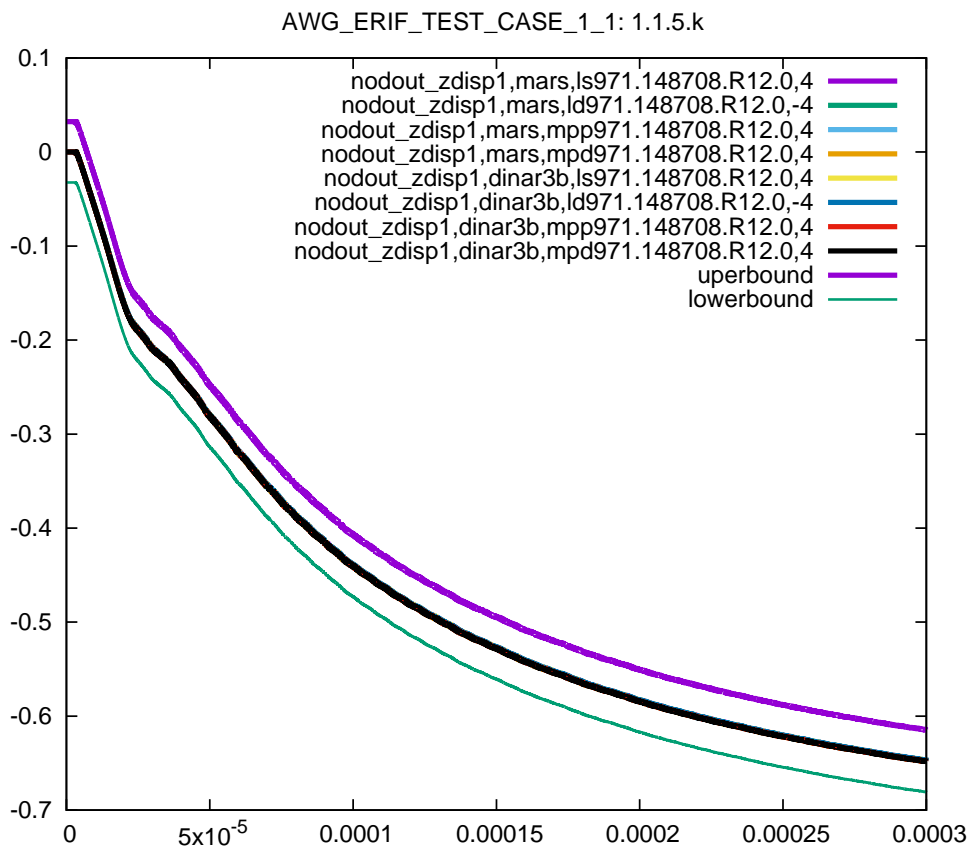

Figure 21: Cross platform results, nodal z displacement node 1, sub test case ID 5, 95% ballistic limit

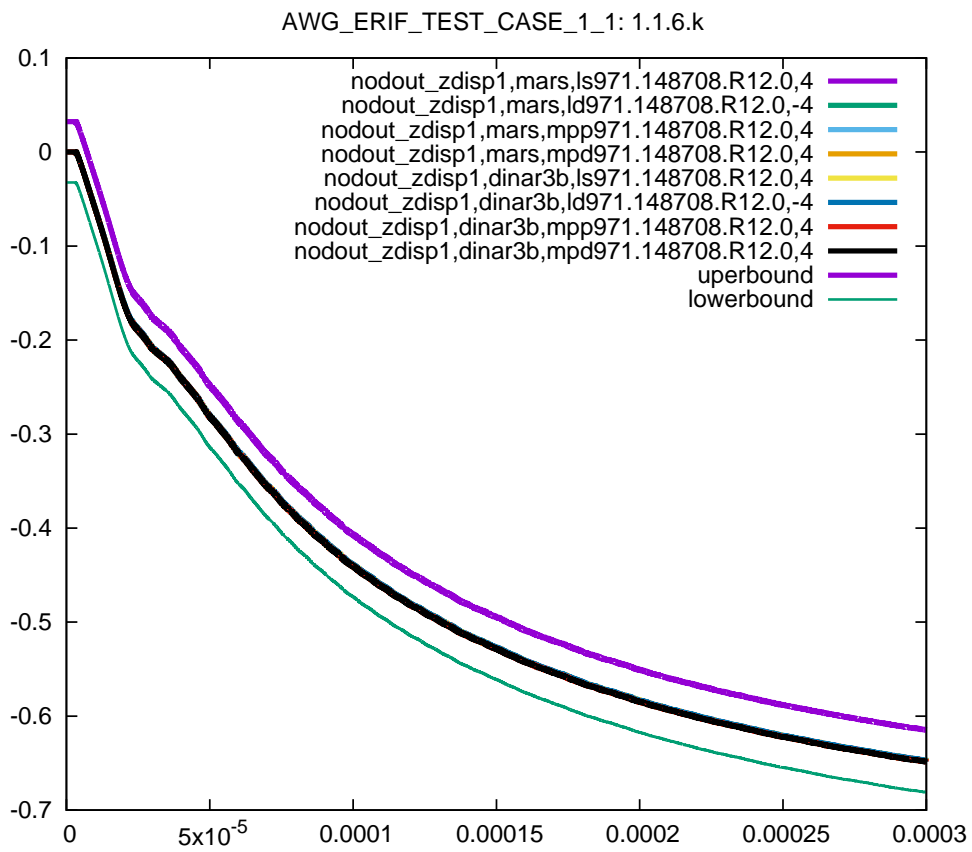

Figure 22: Cross platform results, nodal z displacement node 1, sub test case ID 6, 95% ballistic limit

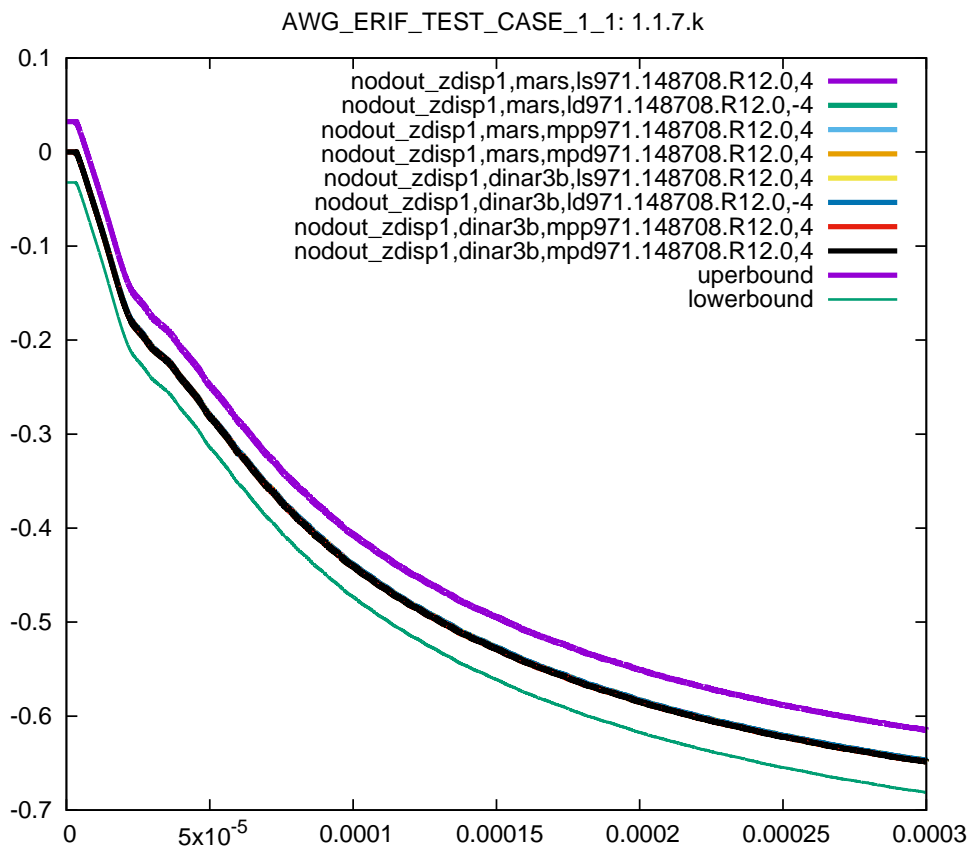

Figure 23: Cross platform results, nodal z displacement node 1, sub test case ID 7, 95% ballistic limit

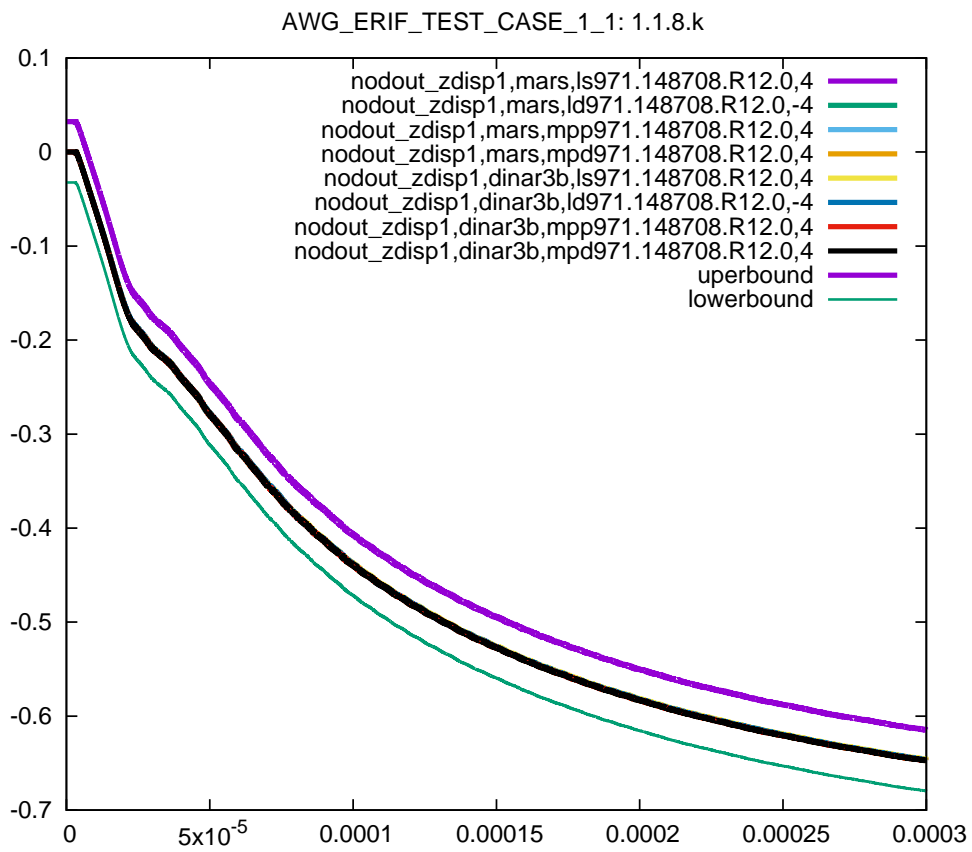

Figure 24: Cross platform results, nodal z displacement node 1, sub test case ID 8, 95% ballistic limit

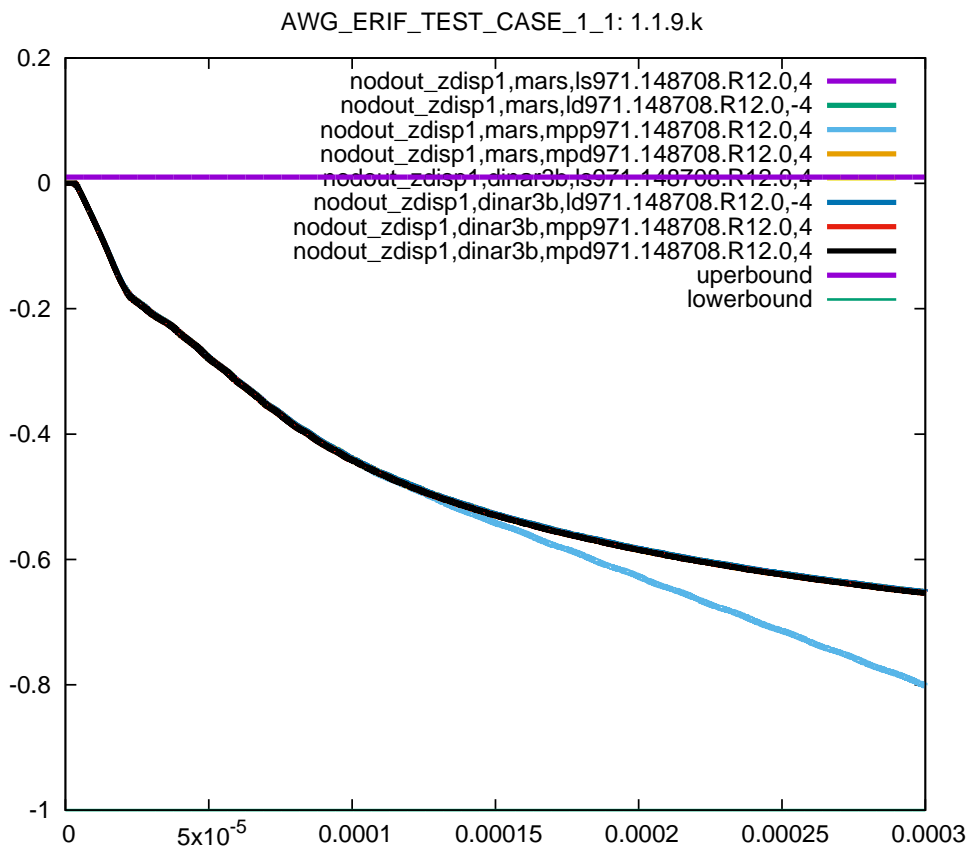

Figure 25: Cross platform results, nodal z displacement node 1, sub test case ID 9, 95% ballistic limit

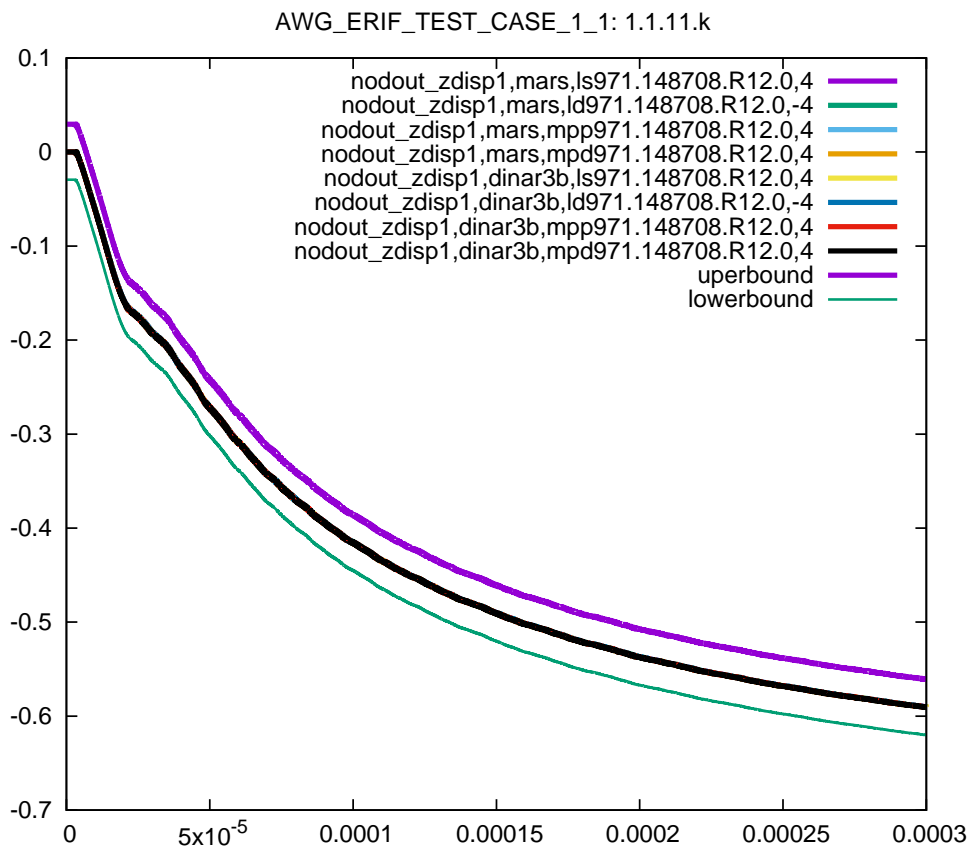

Figure 26: Cross platform results, nodal z displacement node 1, sub test case ID 11, 95% ballistic limit

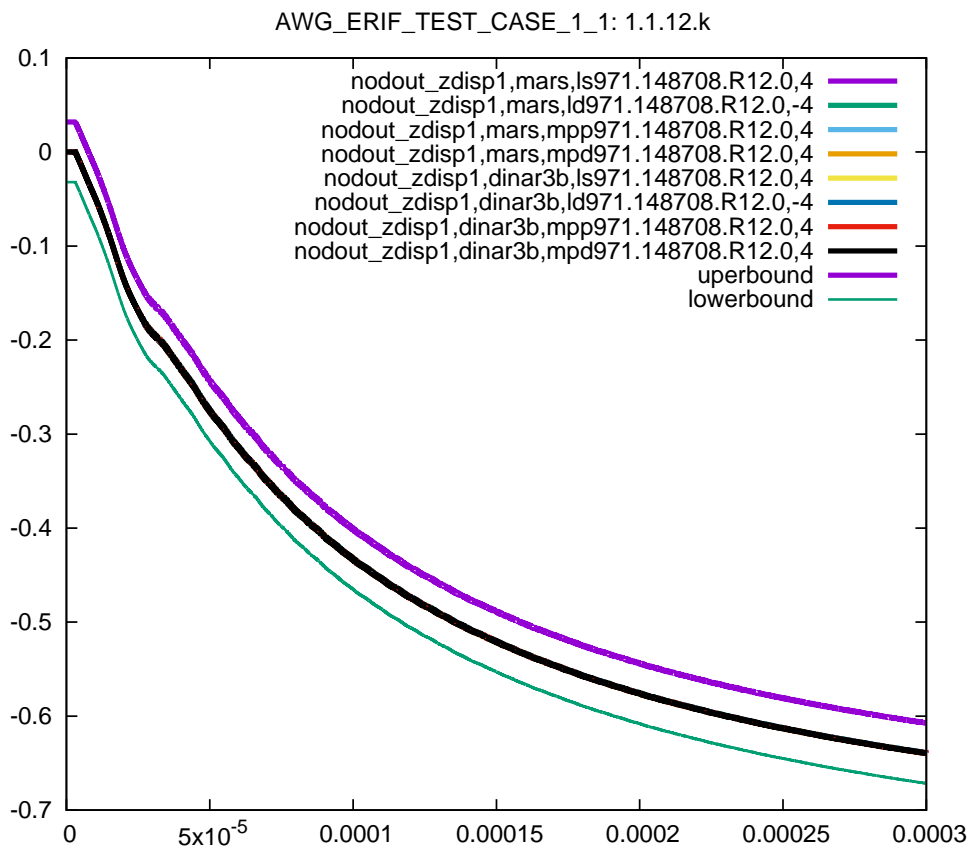

Figure 27: Cross platform results, nodal z displacement node 1, sub test case ID 12, 95% ballistic limit

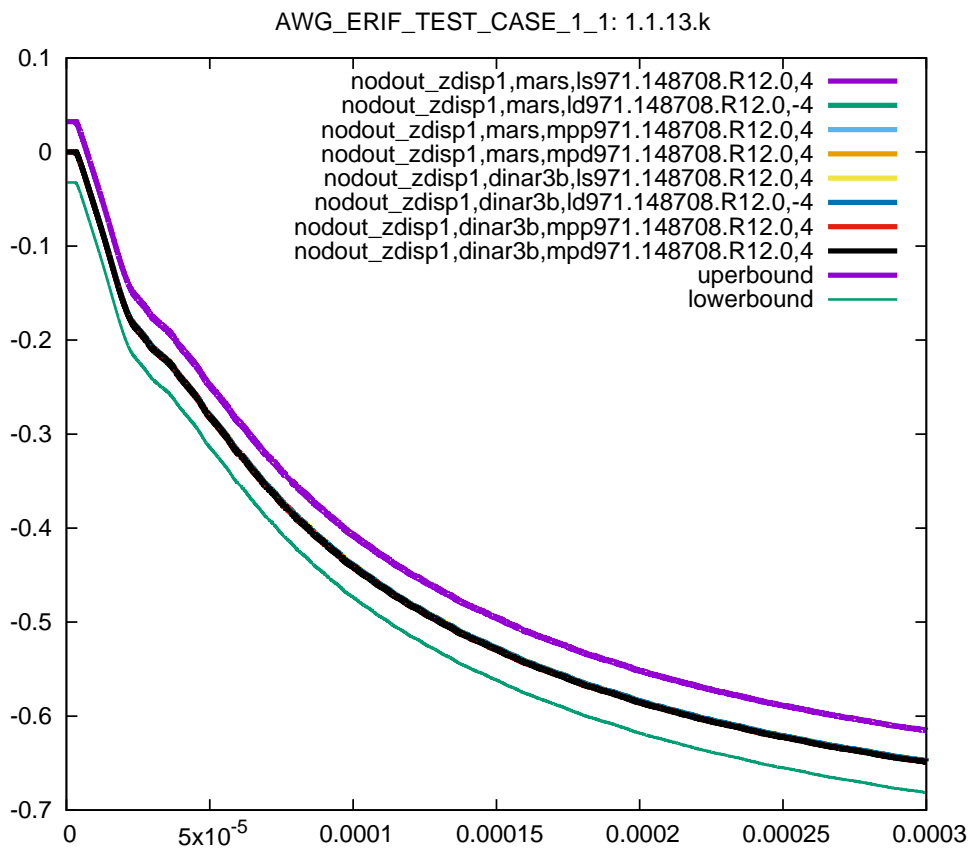

Figure 28: Cross platform results, nodal z displacement node 1, sub test case ID 13, 95% ballistic limit

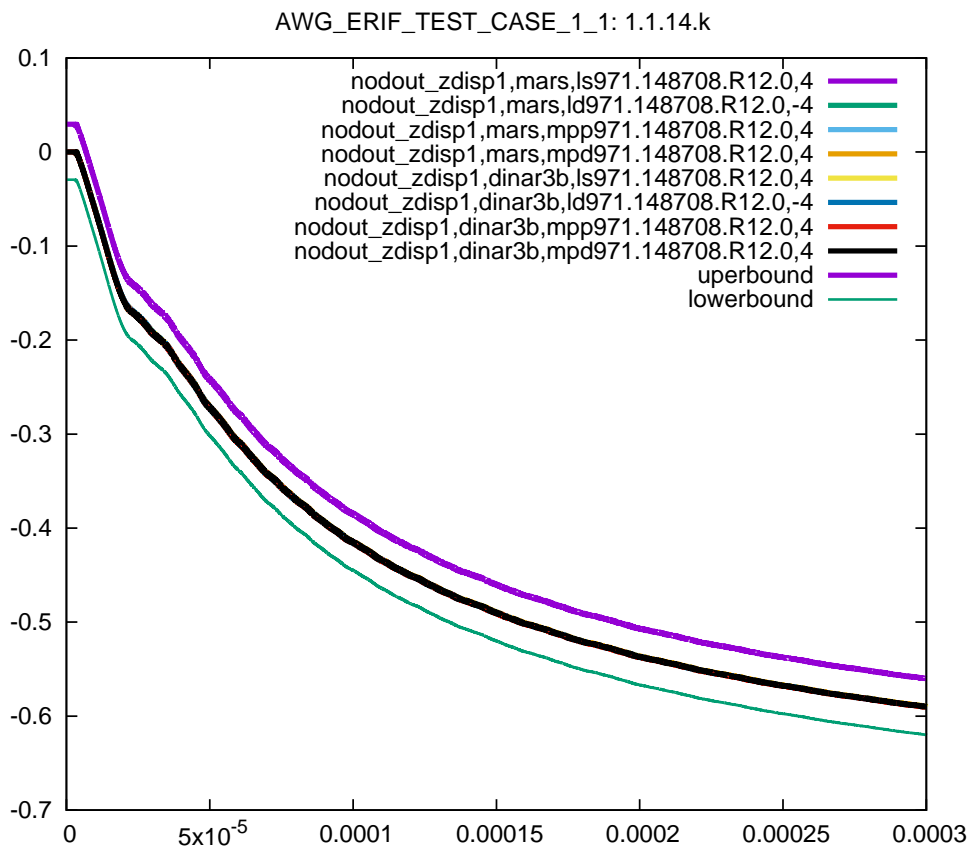

Figure 29: Cross platform results, nodal z displacement node 1, sub test case ID 14, 95% ballistic limit

5.3.3 Test Target 2 (input deck with 105% of the ballistic limit)

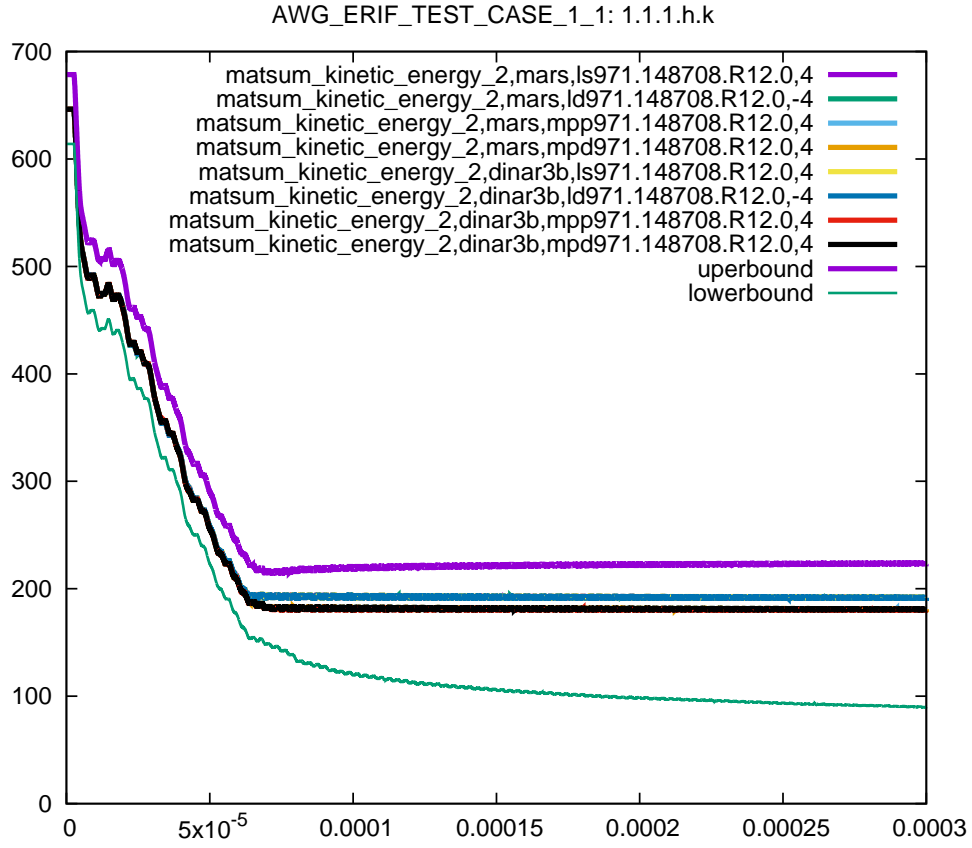

Figure 30: Cross platform results, kinetic energy part 2, sub test case ID 1, 105% ballistic limit

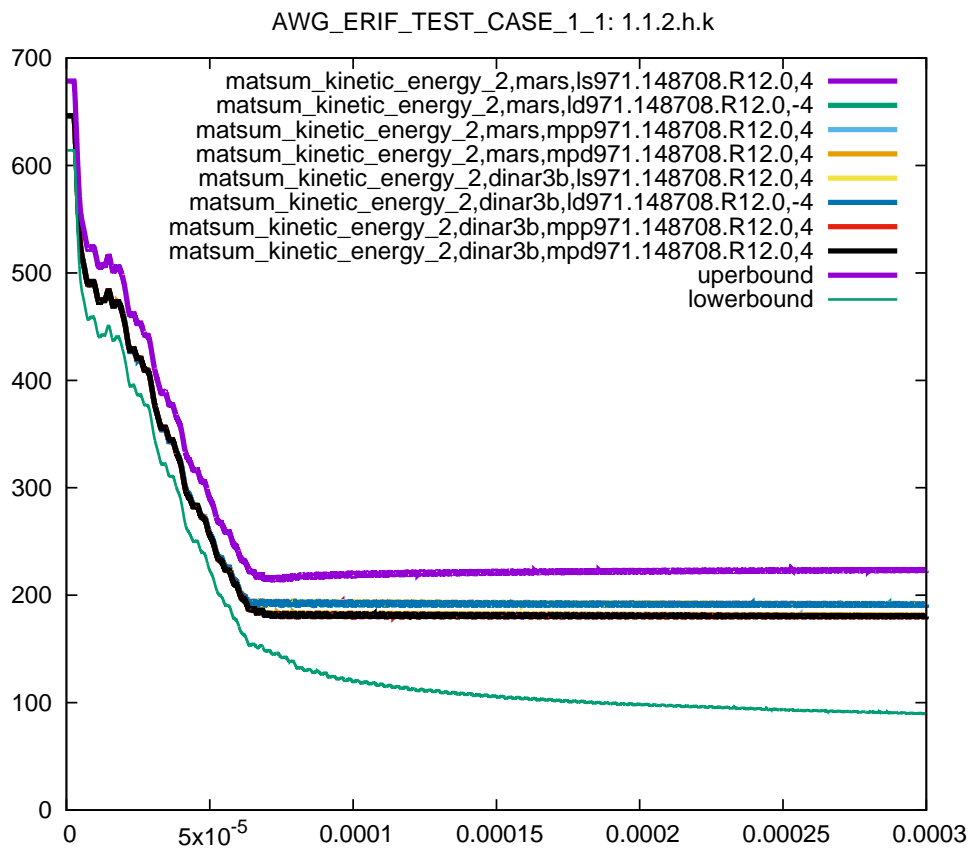

Figure 31: Cross platform results, kinetic energy part 2, sub test case ID 2, 105% ballistic limit

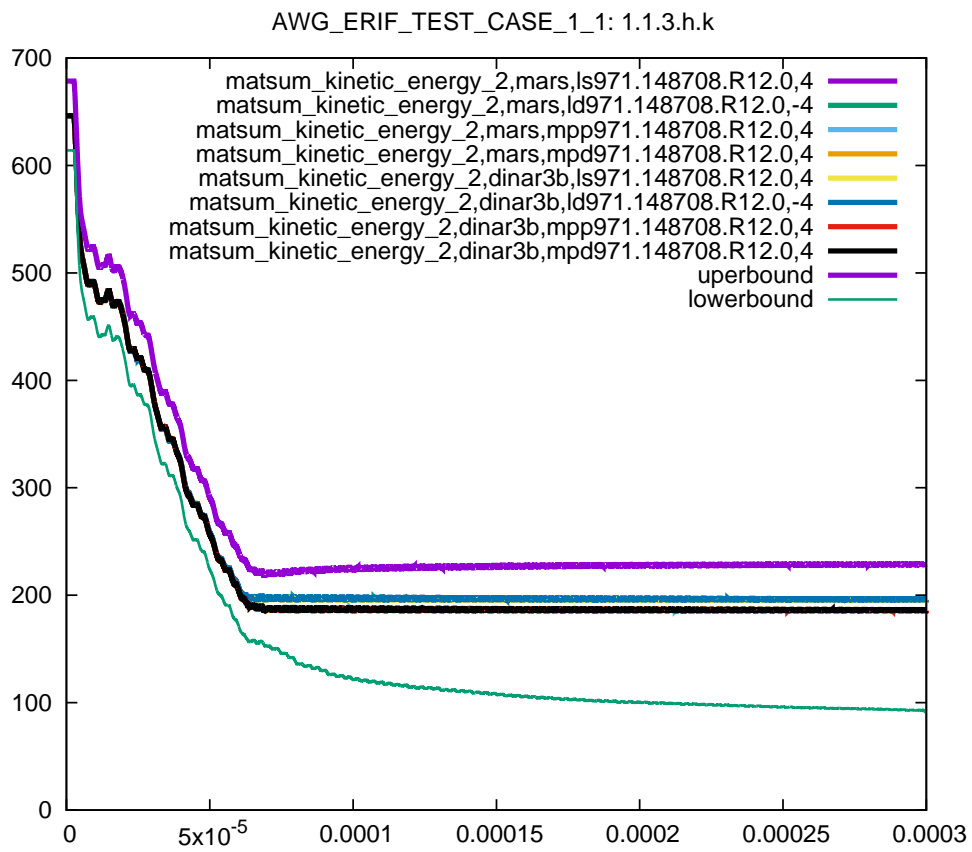

Figure 32: Cross platform results, kinetic energy part 2, sub test case ID 3, 105% ballistic limit

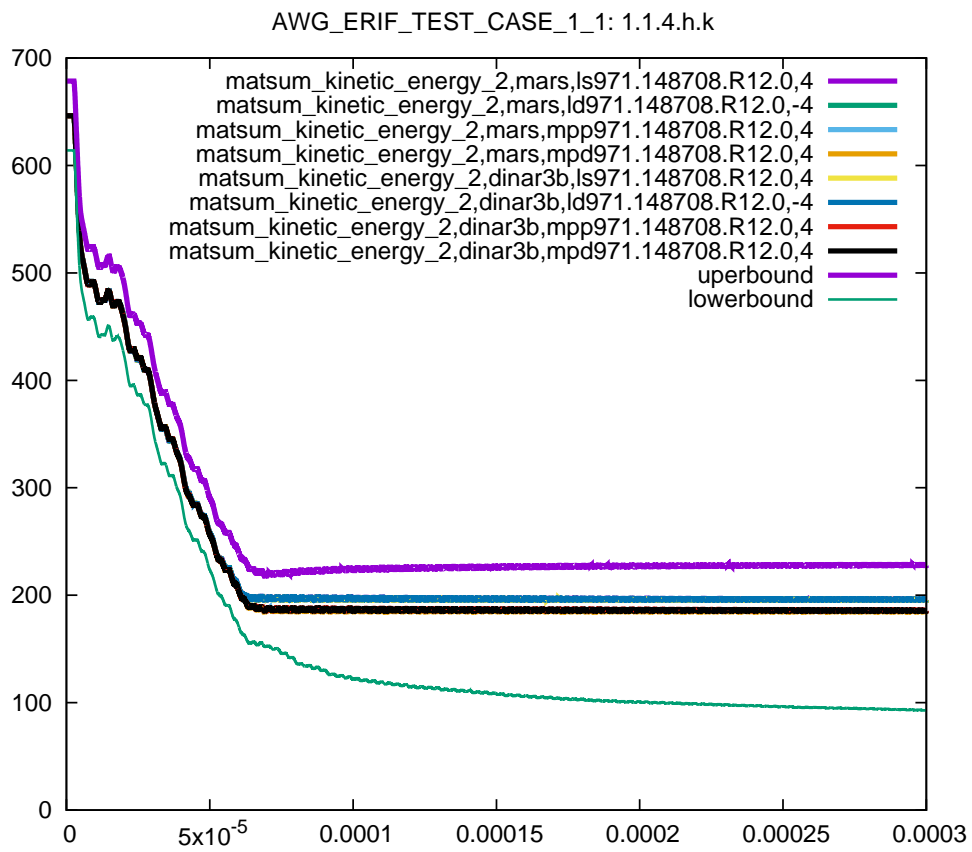

Figure 33: Cross platform results, kinetic energy part 2, sub test case ID 4, 105% ballistic limit

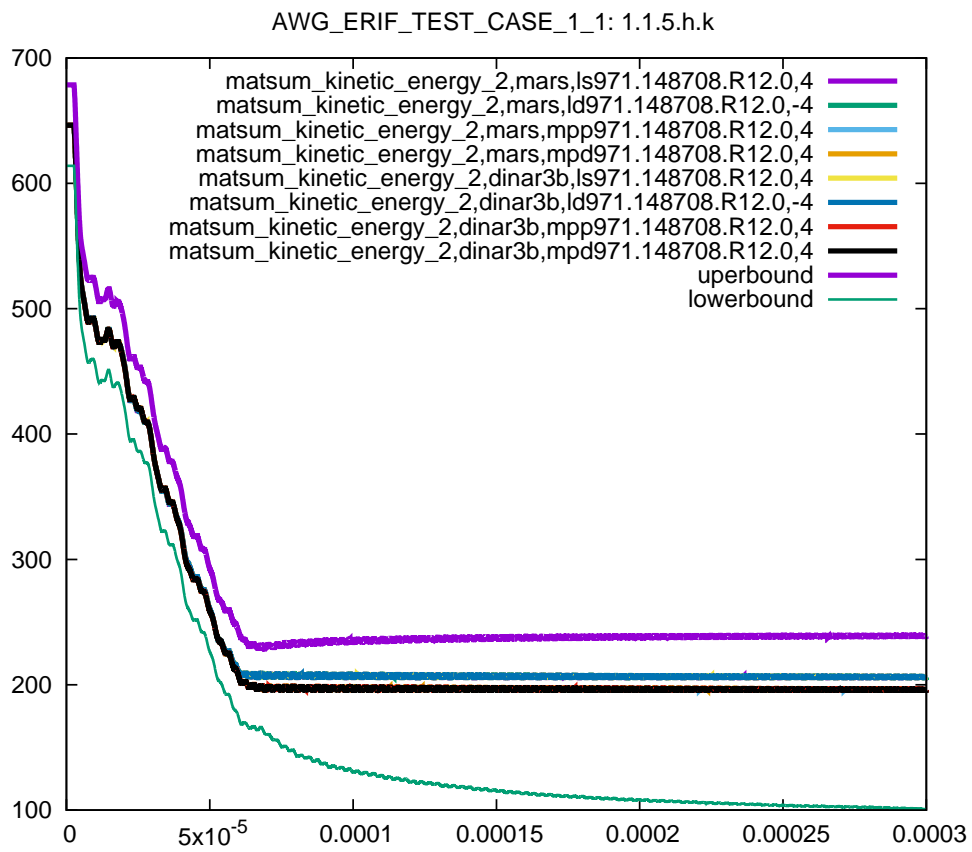

Figure 34: Cross platform results, kinetic energy part 2, sub test case ID 5, 105% ballistic limit

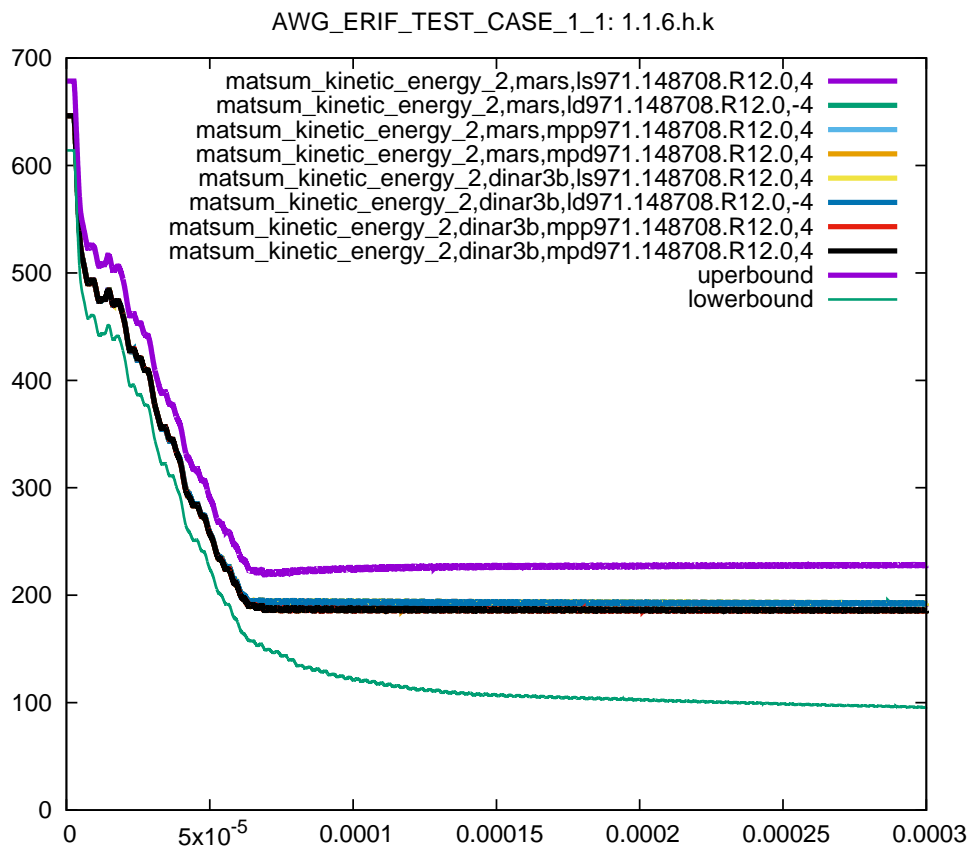

Figure 35: Cross platform results, kinetic energy part 2, sub test case ID 6, 105% ballistic limit

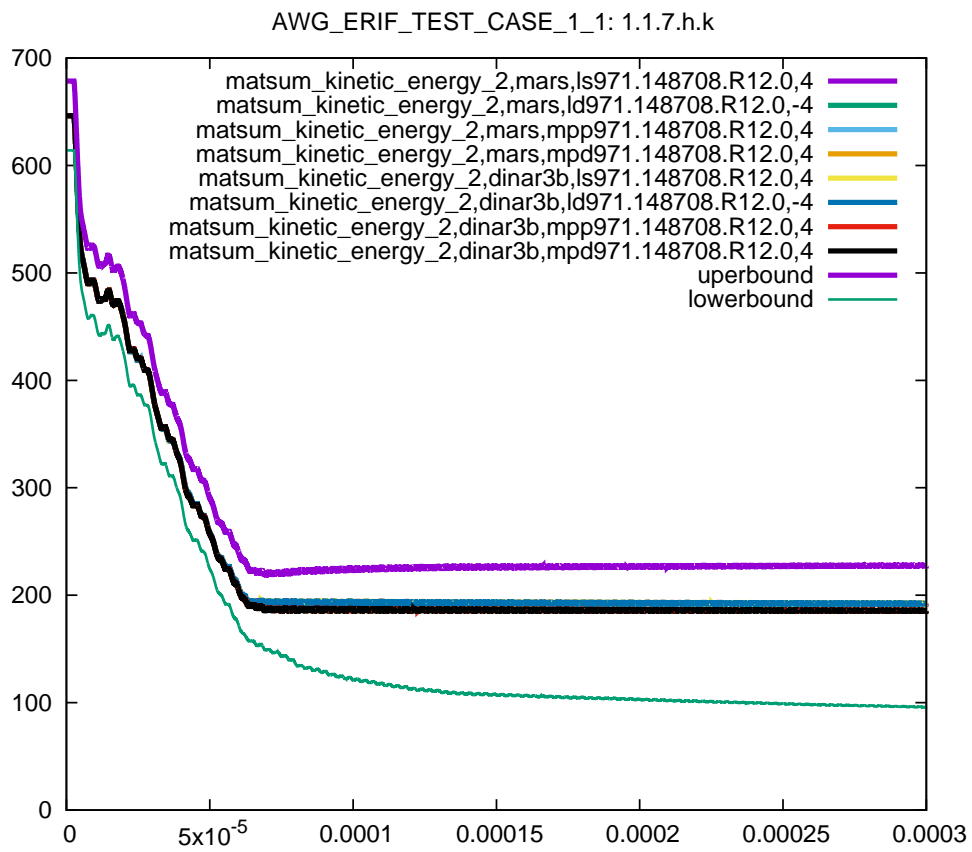

Figure 36: Cross platform results, kinetic energy part 2, sub test case ID 7, 105% ballistic limit

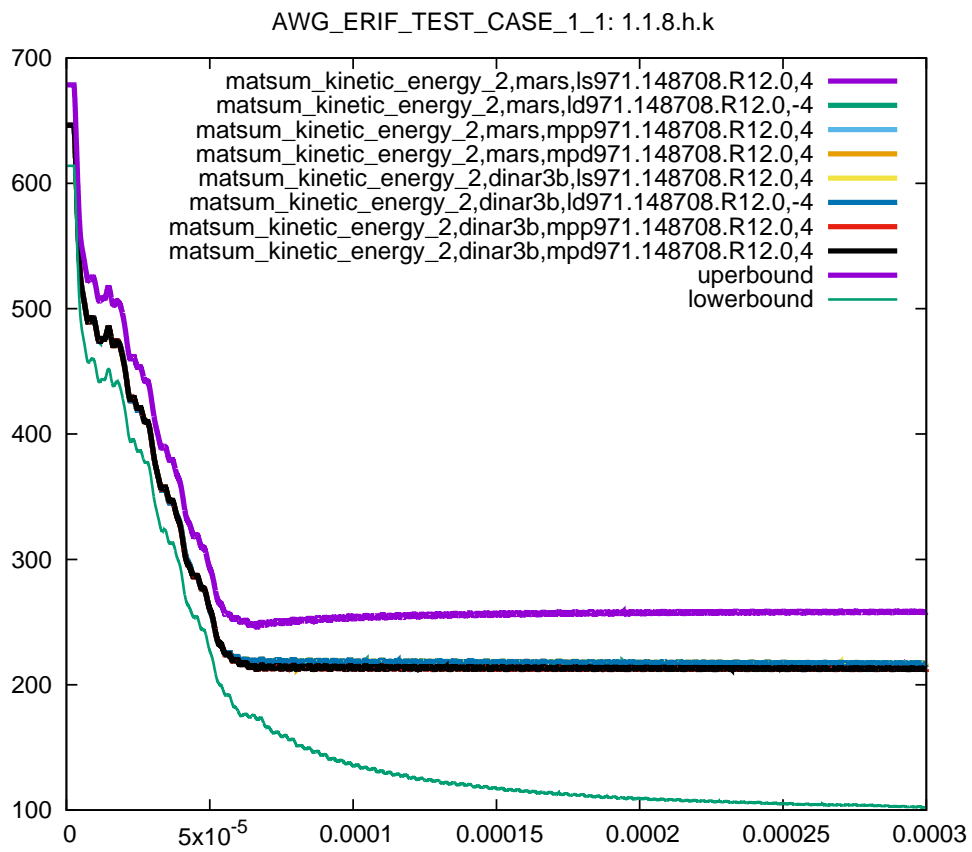

Figure 37: Cross platform results, kinetic energy part 2, sub test case ID 8, 105% ballistic limit

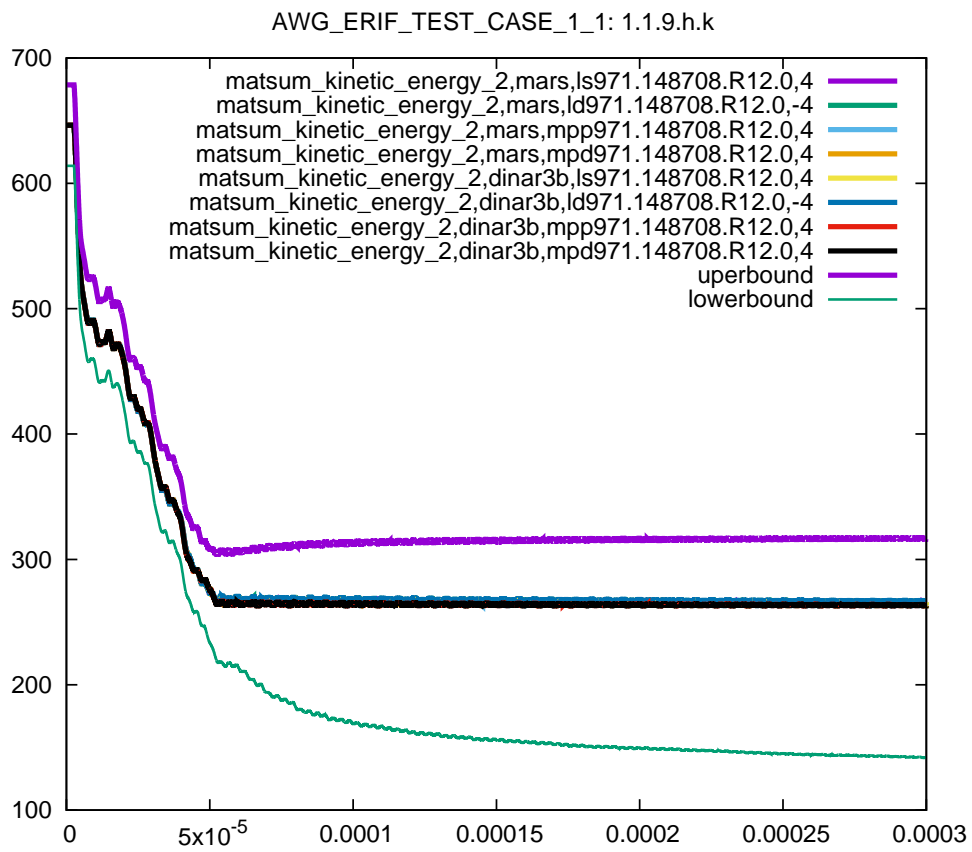

Figure 38: Cross platform results, kinetic energy part 2, sub test case ID 9, 105% ballistic limit

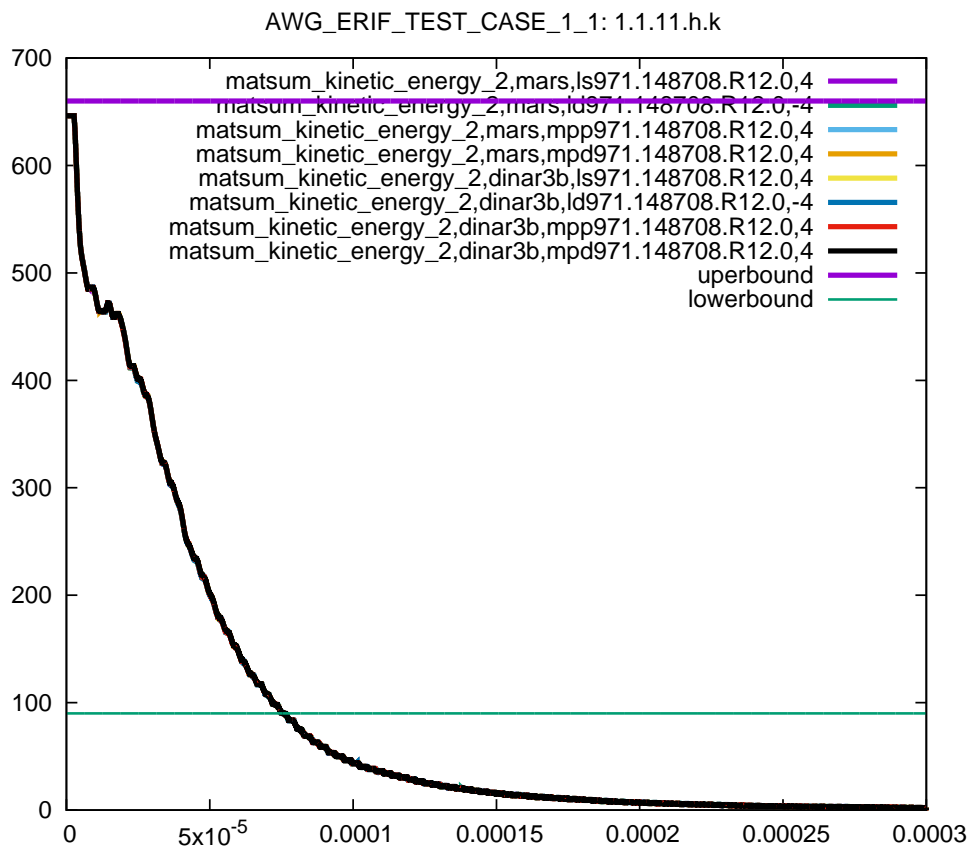

Figure 39: Cross platform results, kinetic energy part 2, sub test case ID 11, 105% ballistic limit

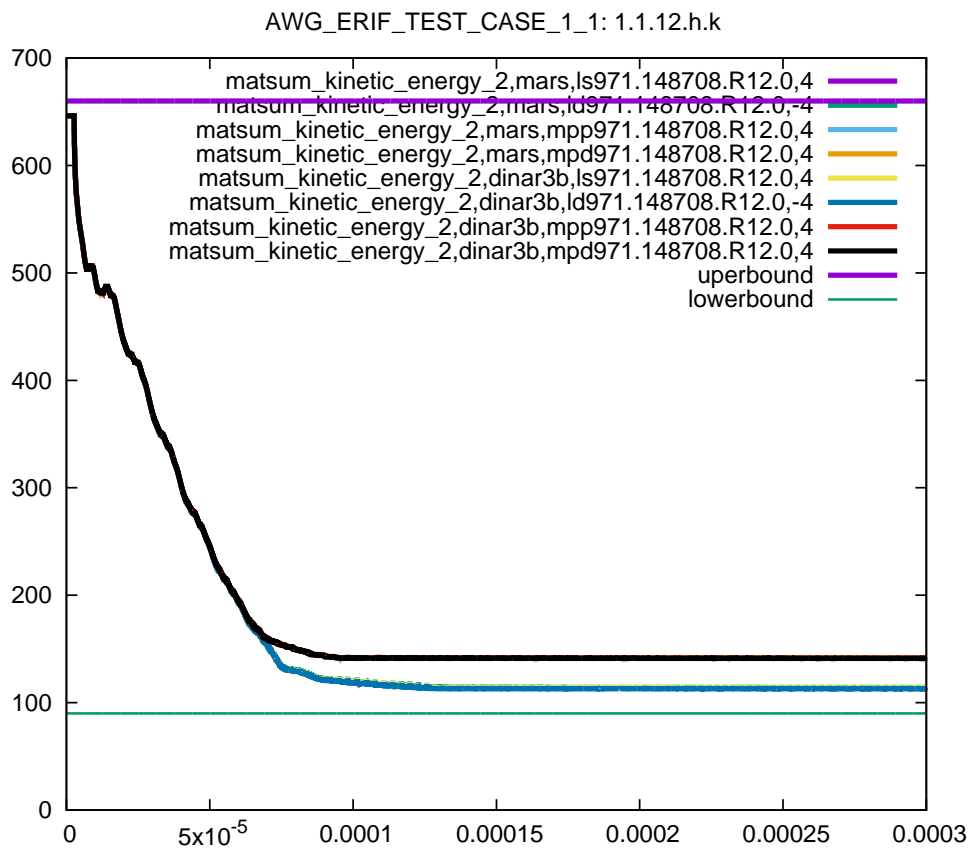

Figure 40: Cross platform results, kinetic energy part 2, sub test case ID 12, 105% ballistic limit

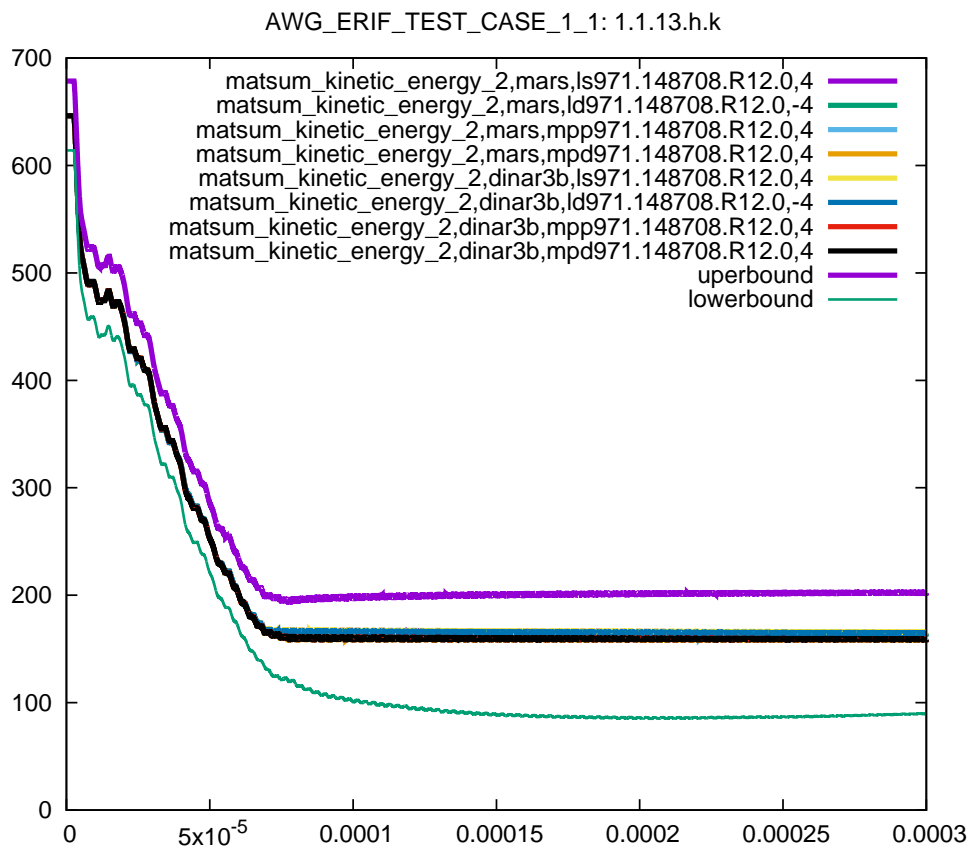

Figure 41: Cross platform results, kinetic energy part 2, sub test case ID 13, 105% ballistic limit

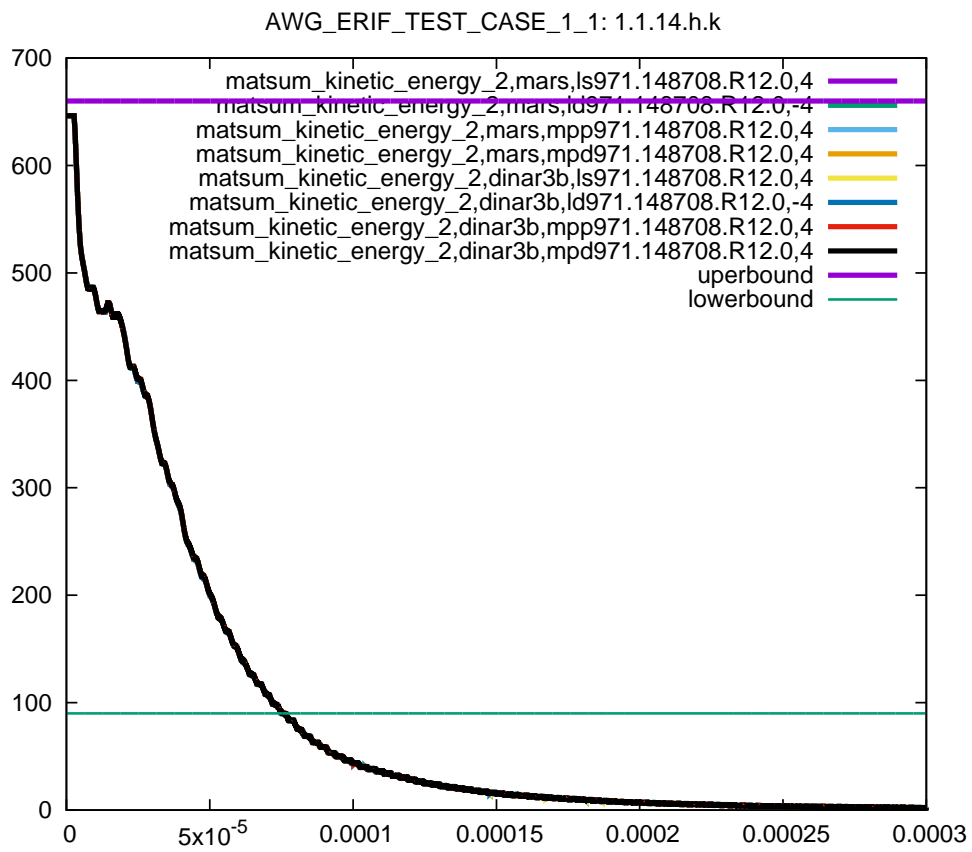

Figure 42: Cross platform results, kinetic energy part 2, sub test case ID 14, 105% ballistic limit

5.3.4 Test Target 2 (input deck with 95% of the ballistic limit)

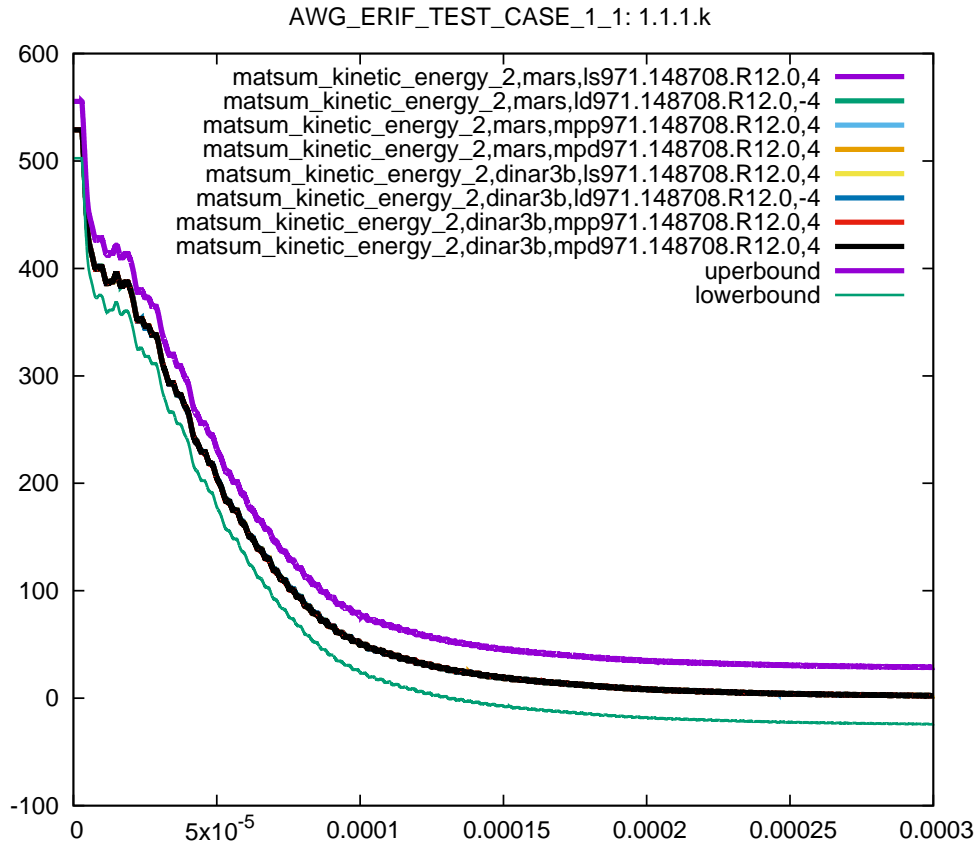

Figure 43: Cross platform results, kinetic energy part 2, sub test case ID 1, 95% ballistic limit

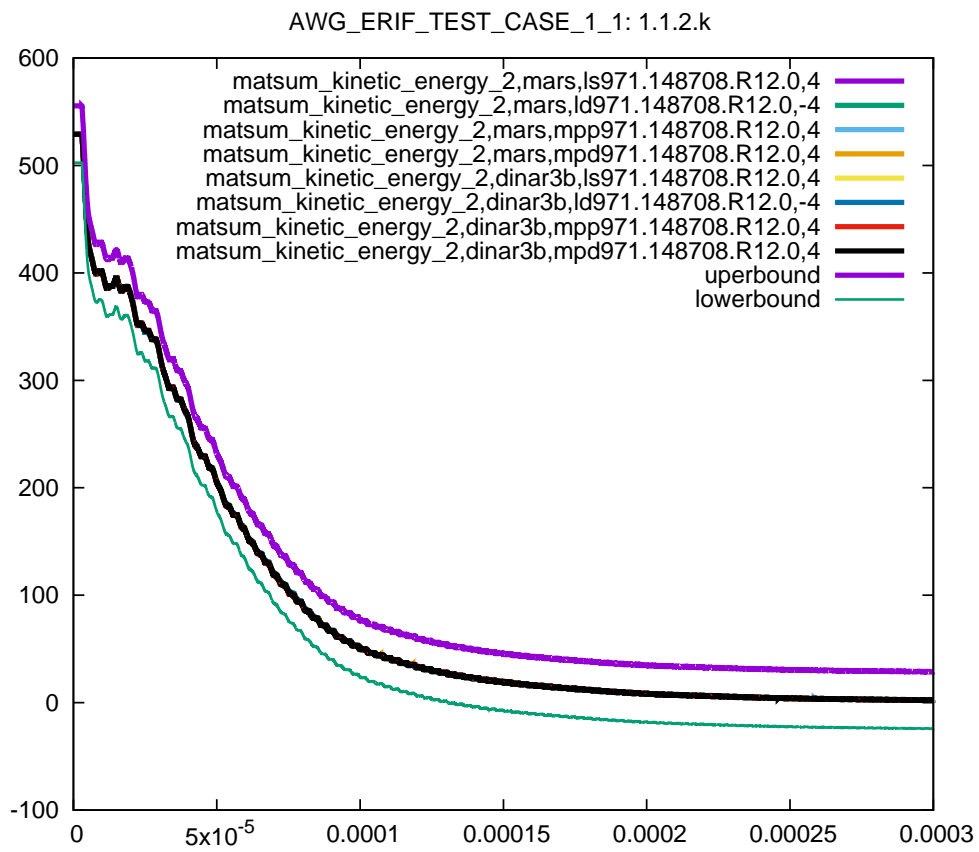

Figure 44: Cross platform results, kinetic energy part 2, sub test case ID 2, 95% ballistic limit

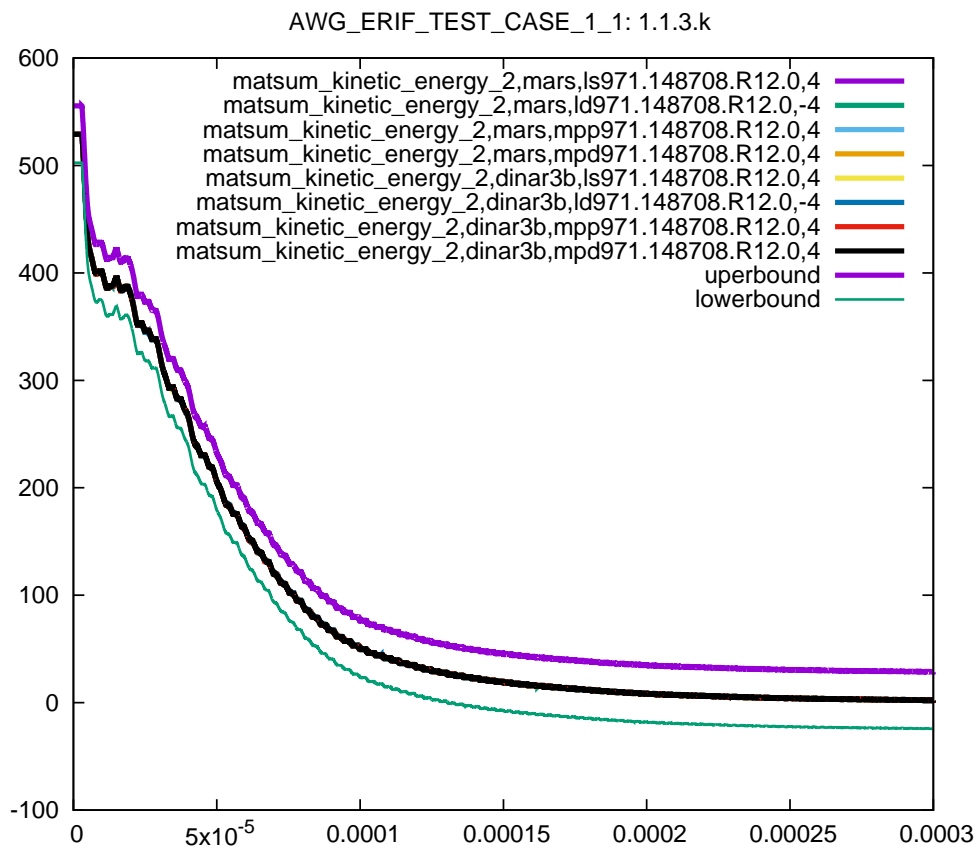

Figure 45: Cross platform results, kinetic energy part 2, sub test case ID 3, 95% ballistic limit

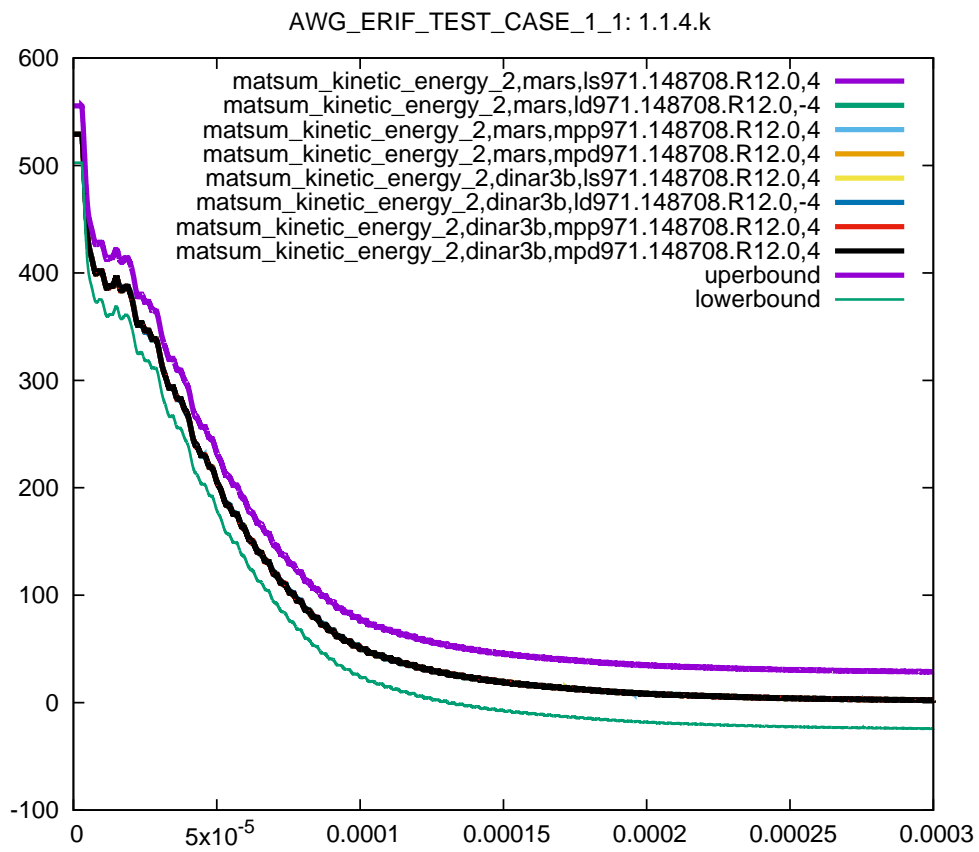

Figure 46: Cross platform results, kinetic energy part 2, sub test case ID 4, 95% ballistic limit

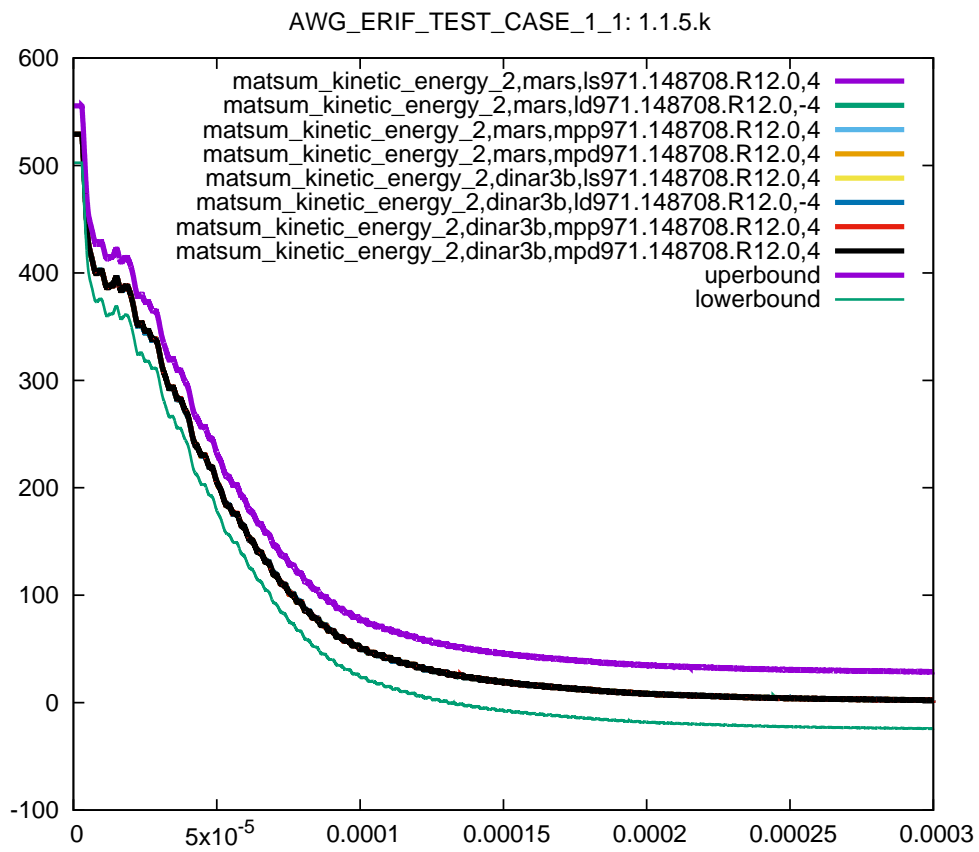

Figure 47: Cross platform results, kinetic energy part 2, sub test case ID 5, 95% ballistic limit

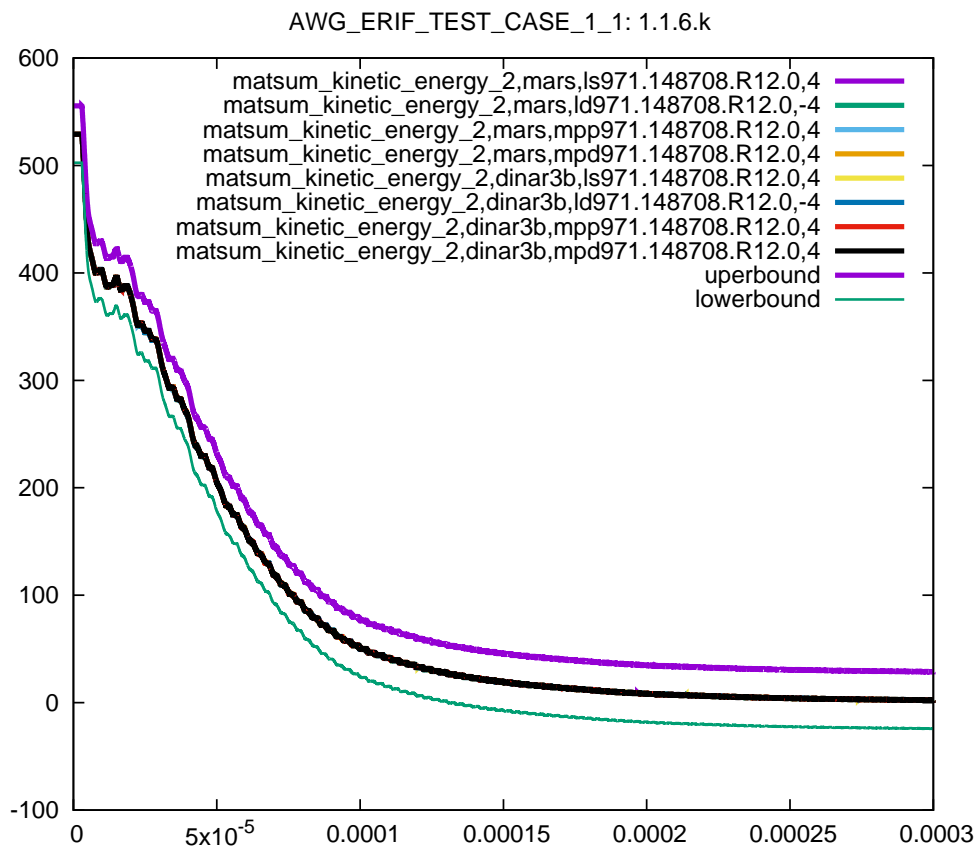

Figure 48: Cross platform results, kinetic energy part 2, sub test case ID 6, 95% ballistic limit

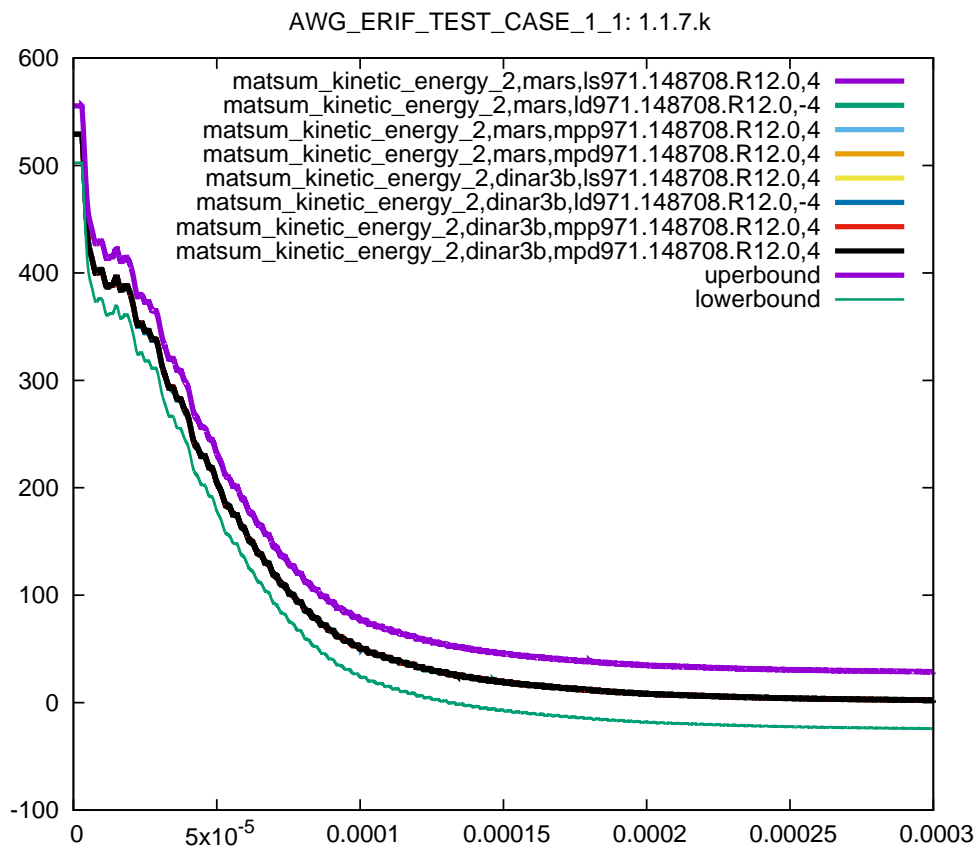

Figure 49: Cross platform results, kinetic energy part 2, sub test case ID 7, 95% ballistic limit

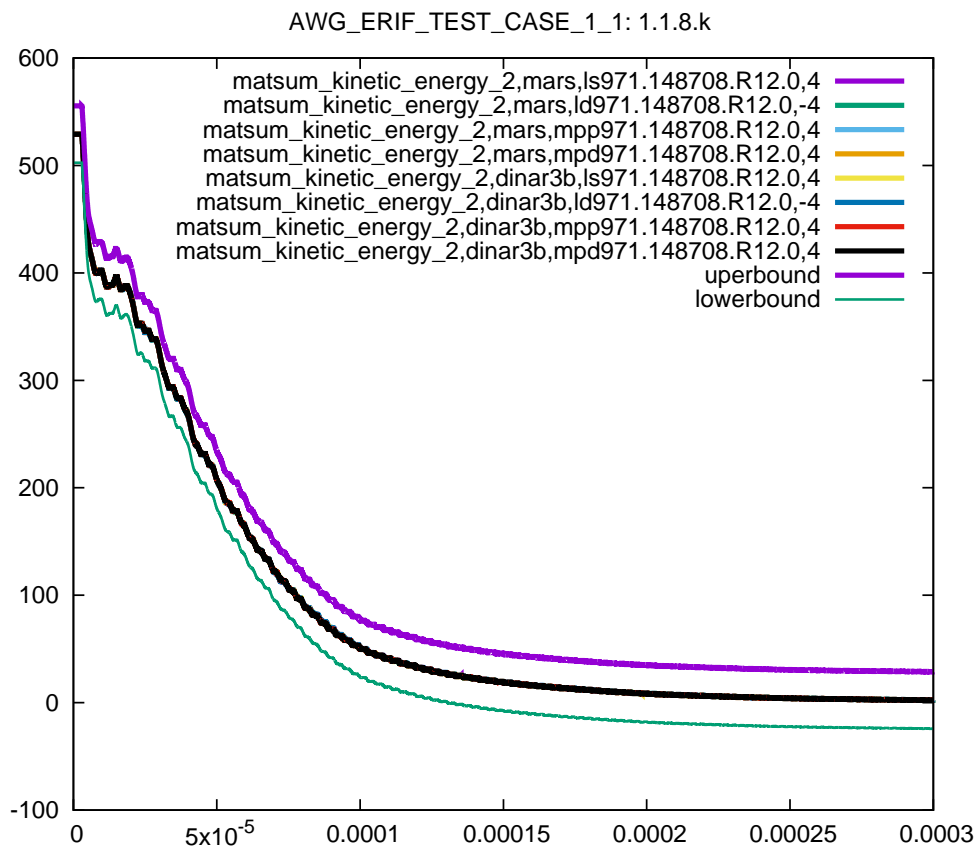

Figure 50: Cross platform results, kinetic energy part 2, sub test case ID 8

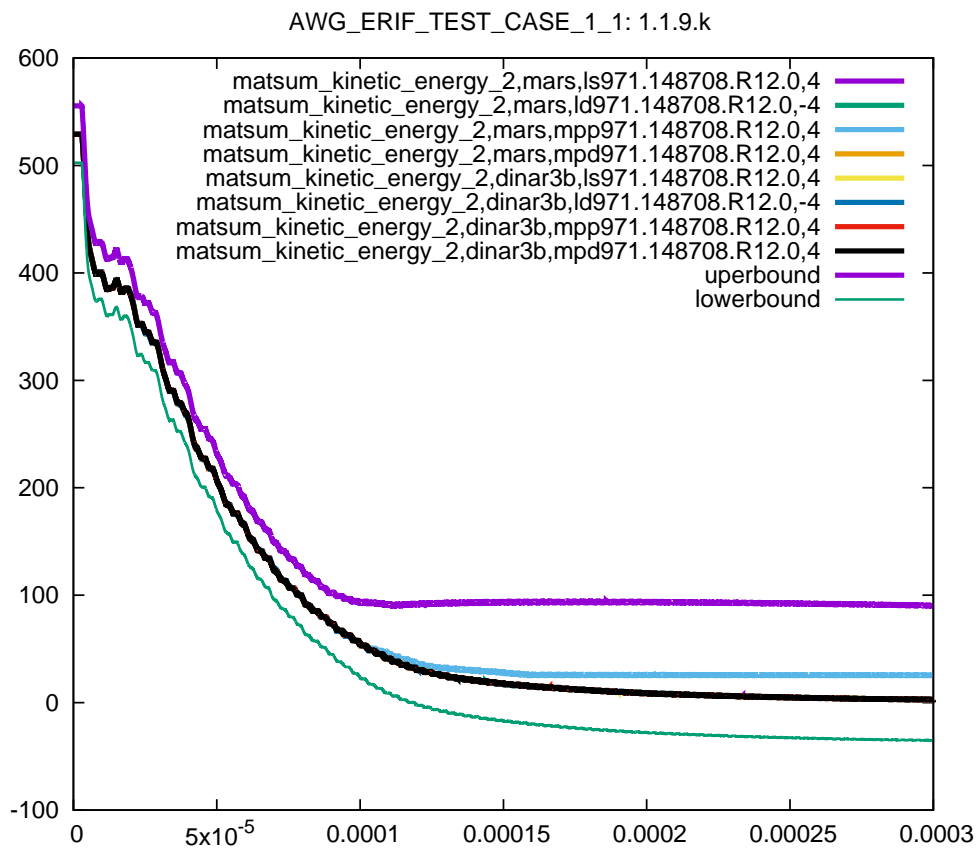

Figure 51: Cross platform results, kinetic energy part 2, sub test case ID 9, 95% ballistic limit

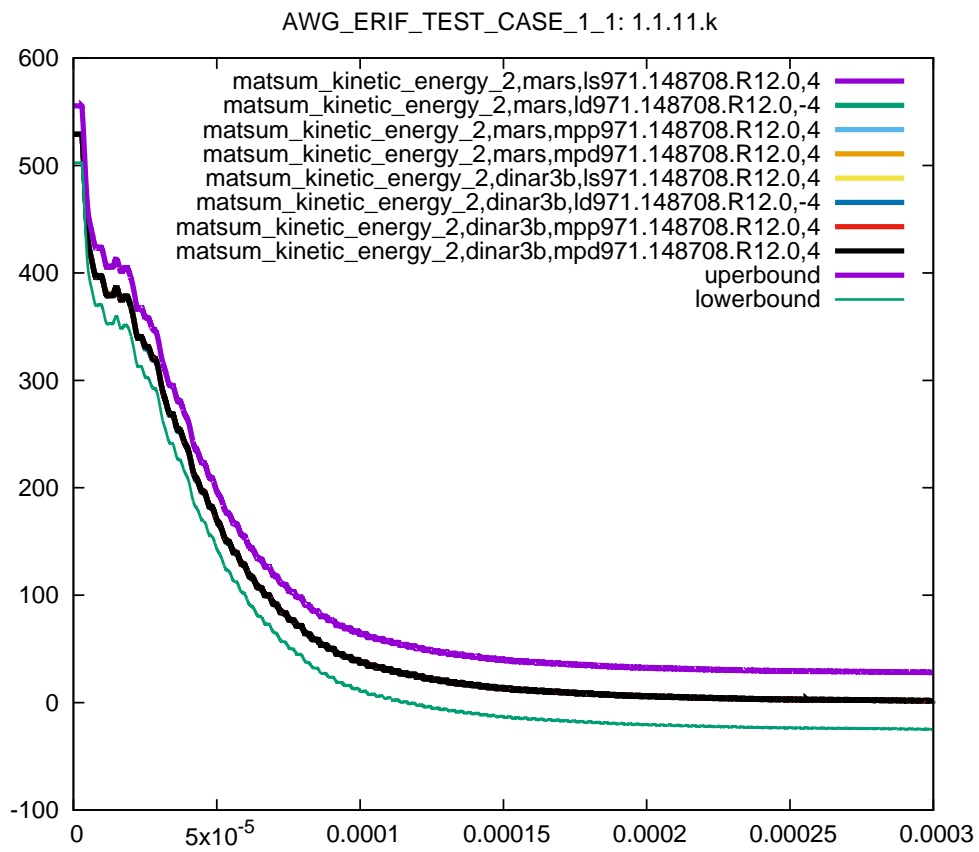

Figure 52: Cross platform results, kinetic energy part 2, sub test case ID 11, 95% ballistic limit

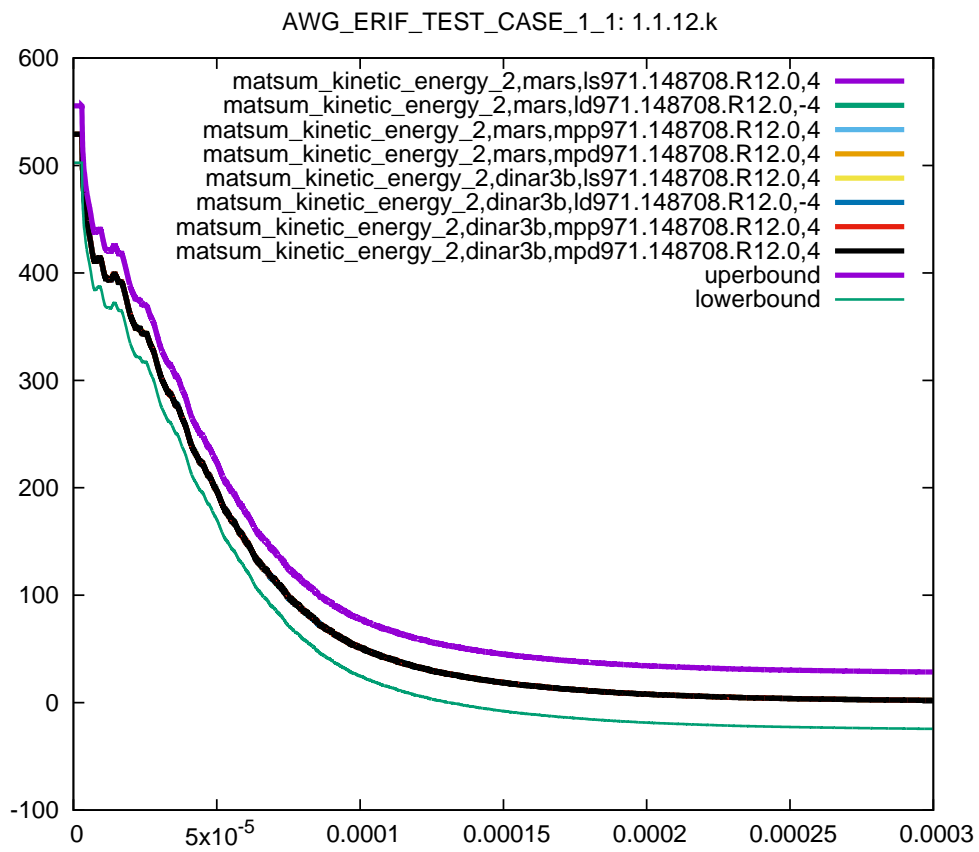

Figure 53: Cross platform results, kinetic energy part 2, sub test case ID 12, 95% ballistic limit

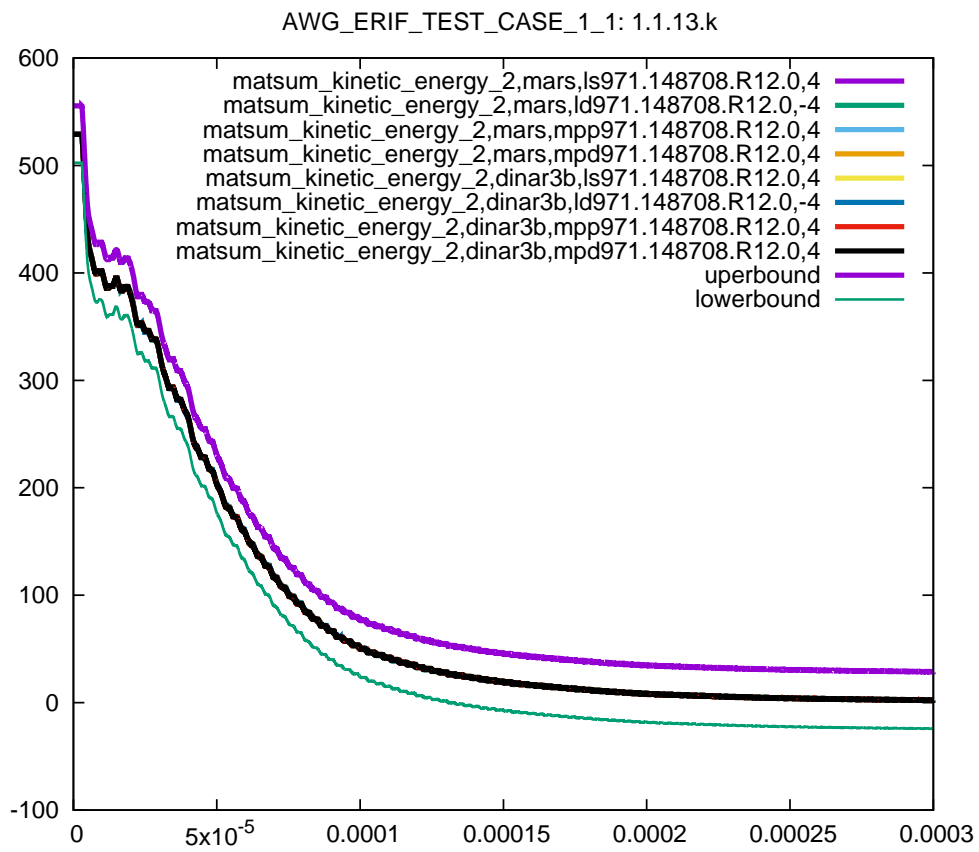

Figure 54: Cross platform results, kinetic energy part 2, sub test case ID 13, 95% ballistic limit

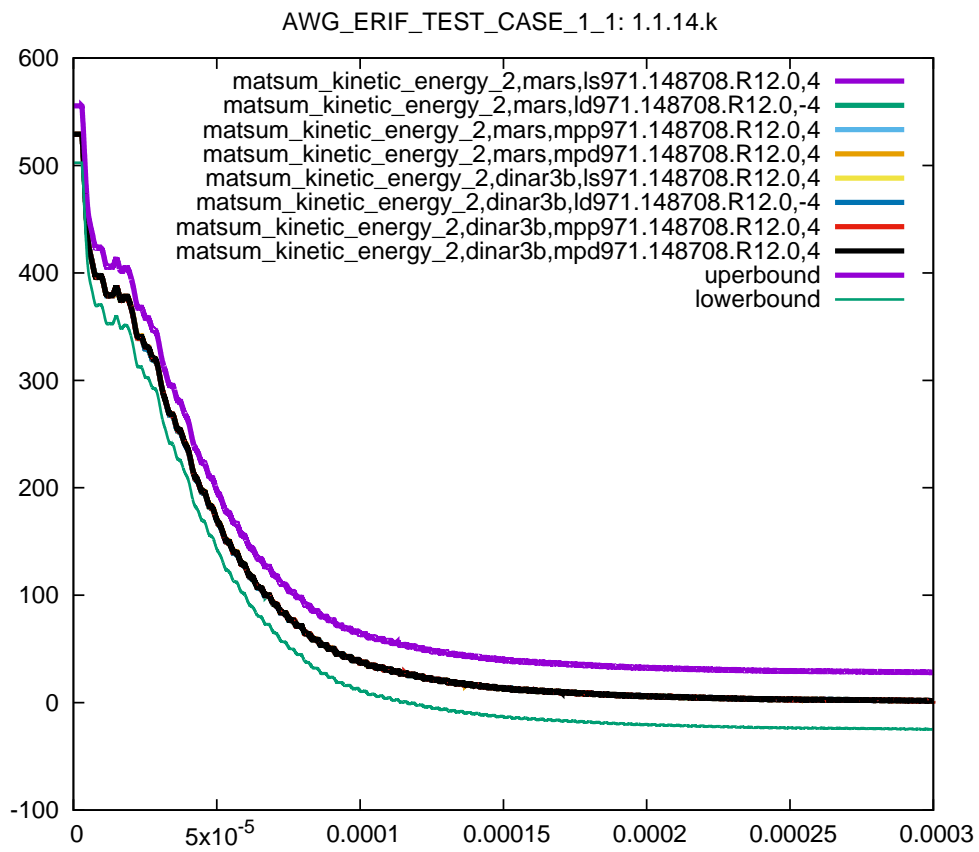

Figure 55: Cross platform results, kinetic energy part 2, sub test case ID 14, 95% ballistic limit

References

- [1] LSTC, *LS-DYNA KEYWORD USER MANUAL*, 7374 Las Positas Road, Livermore, CA, 94551, USA, version 971 ed., May 2007.