

# TEST CASE DOCUMENTATION AND TESTING RESULTS

LSTC-QA-LS-DYNA-AEROQA-1.2-3

## TEST CASE ID AEROQA-1.2

Ballistic Impact:

Ti 6-4 Projectile (solid elements) impacts a  
304L SS plate (solid elements)

Tested with LS-DYNA® R6.1 Revision 74159

Friday 25<sup>th</sup> May, 2012

**Warranty Disclaimer:**

The test case(s) described herein are for illustrative purposes only. LSTC does not warrant that a user of these or other LS-DYNA features will experience the same or similar results or that a feature will meet the user's particular requirements or operate error free. FURTHERMORE, THERE ARE NO WARRANTIES, EITHER EXPRESS OR IMPLIED, ORAL OR WRITTEN, WITH RESPECT TO THE DOCUMENTATION AND SOFTWARE DESCRIBED HEREIN INCLUDING, BUT NOT LIMITED TO ANY IMPLIED WARRANTIES (i) OF MERCHANTABILITY, OR (ii) FITNESS FOR A PARTICULAR PURPOSES, OR (iii) ARISING FROM COURSE OF PERFORMANCE OR DEALING, OR FROM USAGE OF TRADE OR. THE REMEDIES SET FORTH HEREIN ARE EXCLUSIVE AND IN LIEU OF ALL OTHER REMEDIES FOR BREACH OF WARRANTY.

## Document Information

|                     |   |
|---------------------|---|
| Confidentiality     | <b>external use</b>                                 |
| Document Identifier | LSTC-QA-LS-DYNA-AEROQA-1.2-3                        |
| Author(s)           | Prepared by LS-DYNA® Aerospace Working Group        |
| Number of pages     | 36  |
| Date created        | Friday 25 <sup>th</sup> May, 2012                   |
| Distribution        | LS-DYNA® Aerospace Working Group / internal LSTC QA |

# Contents

|   |           |
|---|-----------|
| <b>1 Introduction</b>   | <b>1</b>  |
| 1.1 Purpose of this Document . . . . .                                      | 1         |
| <b>2 Test Case Information</b>  | <b>2</b>  |
| <b>3 Test Case Specification</b>  | <b>3</b>  |
| 3.1 Test Case Purpose . . . . .   | 3         |
| 3.2 Test Case Description . . . . .   | 4         |
| 3.3 Model Description . . . . .   | 6         |
| <b>4 Test Specifications</b>  | <b>8</b>  |
| 4.1 Test Case Targets . . . . .   | 8         |
| 4.2 Pass/Fail Criteria . . . . .  | 8         |
| <b>5 Test Case Results</b>  | <b>9</b>  |
| 5.1 Software and Hardware Specifications . . . . .                          | 9         |
| 5.2 Results Summary . . . . .   | 10        |
| 5.3 Result Details . . . . .  | 11        |
| 5.3.1 Test Target 1 (input deck with 105% of the ballistic limit) . . . . . | 12        |
| 5.3.2 Test Target 1 (input deck with 80% of the ballistic limit) . . . . .  | 18        |
| 5.3.3 Test Target 2 (input deck with 105% of the ballistic limit) . . . . . | 24        |
| 5.3.4 Test Target 2 (input deck with 80% of the ballistic limit) . . . . .  | 30        |
| <b>References</b>   | <b>36</b> |

# **1 Introduction**

## **1.1 Purpose of this Document**

This document specifies the test case AEROQA-1.2. It provides general test case information like name and ID as well as information to the confidentiality, status, and classification of the test case.

A detailed description of the test case is given, the purpose of the test case is defined, and the tested features are named. The test case specifications also state the target measures for testing and the expected results, as well as their pass and fail criteria.

Testing results are provided in section 5 for the therein mentioned LS-DYNA® version and platforms.

## 2 Test Case Information

| Test Case Summary        |   |
|--------------------------|---|
| Confidentiality          | external use  |
| Test Case Name           | Ballistic Impact: Ti 6-4 Projectile (solid elements) impacts a 304L SS plate (solid elements)   |
| Test Case ID             | AEROQA-1.2  |
| Test Case Status         | active  |
| Test Case Classification | Validation  |
| Test Case Source         | NASA Glenn Research Center  |
| Tested Keyword           | *ELEMENT_SOLID; *SECTION_SOLID, ELFORM=1,2<br>*HOURGLASS; *MAT_024 (PIECEWISE_LINEAR_PLASTICITY) VP=0,1<br>*MAT_015 (JOHNSON_COOK) VP=0,1<br>*MAT_123 (MODIFIED_PIECEWISE_LINEAR_PLASTICITY) VP=0,1 |
| Member of Test Suite     | AEROQA SUITE  |
| Metadata                 | AEROQA  |

Table 1: Test Case Summary

## **3 Test Case Specification**

### **3.1 Test Case Purpose**

The purpose of QA Test Case ID AEROQA-1.2 is the validation of an impact experiment performed at NASA Glenn Research Center. The reliability and consistency of LS-DYNA<sup>®</sup> as a finite element solver for this impact simulation is evaluated by performing analyses with various material models, element formulations/options, contact algorithm options, and hourglass algorithms (see table 4).

### 3.2 Test Case Description

This QA Test Case contains a ballistic impact of a Ti 6-4 projectile on a 304L SS plate (see figure 1). An experiment with a 7"x7"x0.105" 304L SS steel plate was chosen as the model geometry and material specification. The ballistic limit was determined by the experimental results (see figure 2).

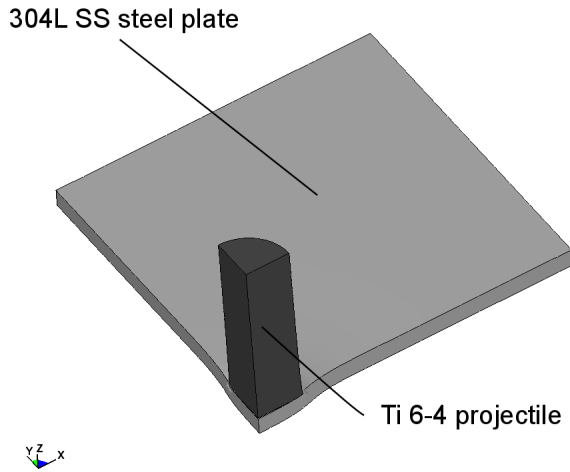

Figure 1: Model: Ballistic Impact - Ti 6-4 projectile impacts a 304L SS plate

The experiment is modelled via a lagrangian approach with solid elements for the steel plate and for the projectile. A summary of the experimental set-up can be found in table 2.

| Physical Model Information                         |                              |
|--|------------------------------|
| plate geometry                                     | 7"x7"x0.105"                 |
| plate material                                     | 304L SS steel                |
| projectile geometry                                | length = 1" , radius = 0.25" |
| projectile material                                | Ti 6-4                       |
| projectile velocity (ballistic limit see figure 2) | 937 ft/s                     |

Table 2: Experimental set-up data

The ballistic limit for a variety of impact experiments was provided by NASA Glenn Research Center (see figure 2).

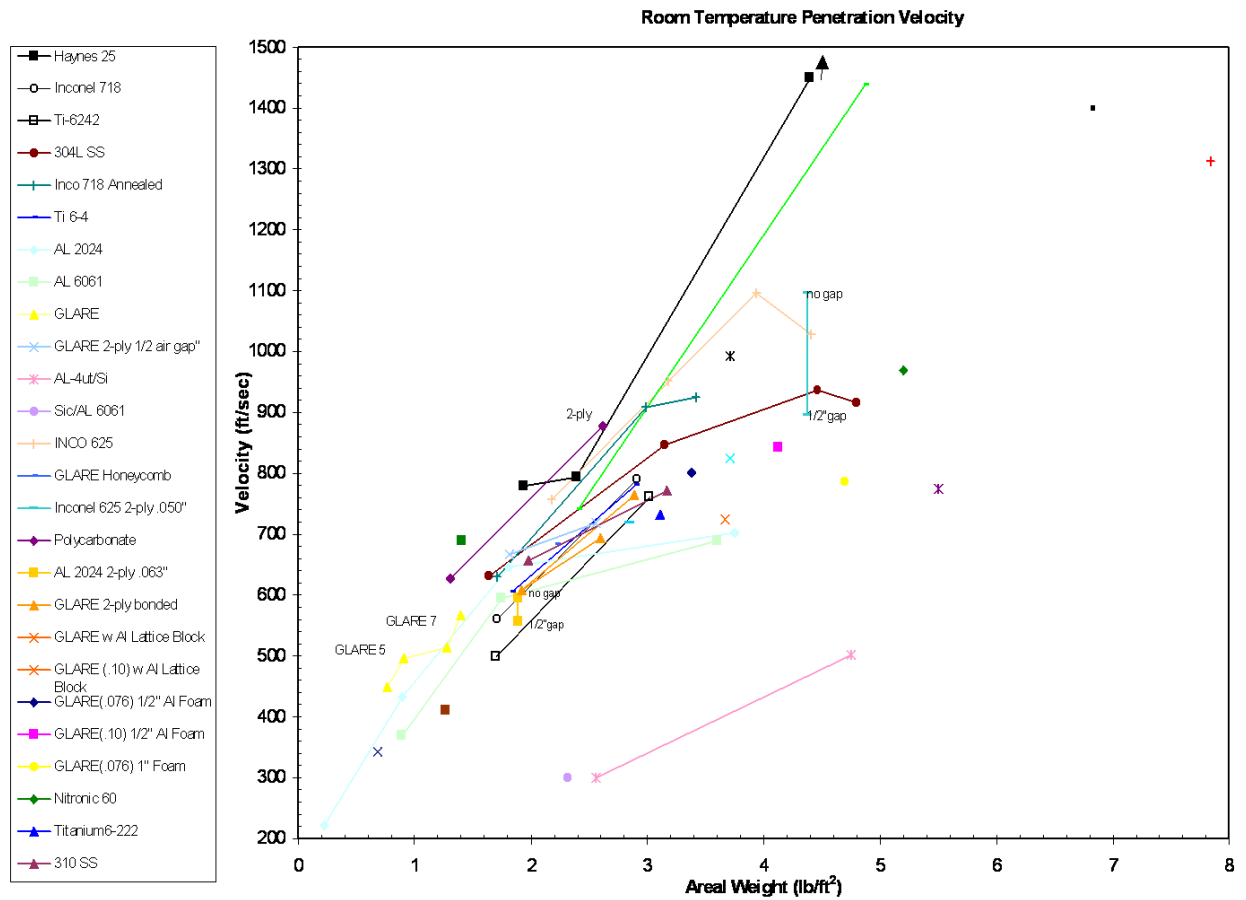

Figure 2: Experimental results: ballistic limit of various impact tests

### 3.3 Model Description

The model geometry is discretized with solid elements for the projectile and the steel plate (see figure 3). See table 3 for the number of elements and material specifications for the model. Due to symmetry conditions, a quarter model of the actual geometry is used. Symmetry boundary conditions are applied on the symmetry plane and the outer edges of the steel plate are simply supported. The projectile has an initial z velocity defined on all nodes and is guided along the z axis by boundary conditions applied in the x and y direction on the symmetry plane.

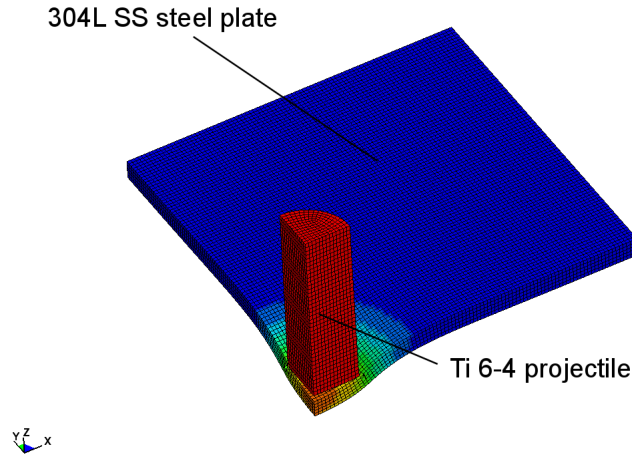

Figure 3: FEA Model: Ballistic Impact - Ti 6-4 projectile impacts a 304L SS plate

| Model information   |   |
|---------------------|---|
| Nodes               | 59296   |
| Solid elements      | 47165   |
| Solid materials     | 2   |
| Parts               | 2   |
| Plate geometry      | 1.82"x1.82"x0.105"  |
| Projectile geometry | length = 1" , radius = 0.25"  |
| Units               | in (length), s (time), lbf-s <sup>2</sup> /in (mass), psi (stress), lbf-in (energy) |

Table 3: FEA Model Information

Eleven variations (called sub test cases) of the model are set up with different solid element formulations for the steel plate (parameter ELFORM), different material algorithms for the material behaviour, different contact algorithm options (parameter SOFT), and different approaches to hourglass stabilization (parameter IHQ). A summary of these eleven sub test cases and the specific values for the parameters in each test case can be found in table 4.

For each sub test case, two simulations are performed to verify that the ballistic limit from the simulations is consistent with the experiment. The initial velocity of the projectile is defined to be 80% and 105% of the ballistic limit. Models with an initial velocity of 80% of the ballistic limit should not penetrate the steel plate and models with an initial velocity of 105% of the ballistic limit should penetrate the steel plate.

The material definitions and their parameters can be found in the input decks and were provided by NASA Glenn Research Center.

| Sub Test ID    | ELFORM <sup>1</sup> | MATERIAL <sup>2</sup> | SOFT <sup>3</sup> | IHQ <sup>4</sup> |
|----------------|---------------------|-----------------------|-------------------|------------------|
| 1              | 1                   | MAT_024               | 0                 | 1                |
| 2              | 2                   | MAT_024               | 0                 | 1                |
| 3              | 1                   | MAT_015               | 0                 | 1                |
| 4              | 1                   | MAT_081               | 0                 | 1                |
| 5 <sup>5</sup> | -                   | -                     | -                 | -                |
| 6              | 1                   | MAT_024               | 1                 | 1                |
| 7              | 1                   | MAT_024               | 0                 | 2                |
| 8              | 1                   | MAT_024               | 0                 | 3                |
| 9              | 1                   | MAT_024               | 0                 | 4                |
| 10             | 1                   | MAT_024               | 0                 | 5                |
| 11             | 1                   | MAT_024               | 0                 | 6                |

<sup>1</sup> Parameter ELFORM in \*SECTION,SOLID keyword  
<sup>2</sup> MATERIAL is related to the LS-DYNA material number  
<sup>3</sup> Parameter SOFT in \*CONTACT,AUTOMATIC,NODES,TO,SURFACE keyword  
<sup>4</sup> Parameter IHQ in \*HOURLASS keyword  
<sup>5</sup> Skipped, originally allocated to test \*MAT.058, which is available only for shells

Table 4: Specification of sub test cases

The Test Case contains a total of 20 input decks, derived from the 10 active sub test cases times 2 velocity definitions of 80% and 105% of the ballistic limit respectively.

The input files names have the following format:

- **1.2.sub test ID.k** for the test cases with a projectile velocity of 80% of the ballistic limit
- **1.2.sub test ID.h.k** for the test cases with a projectile velocity of 105% of the ballistic limit

Herein the leading '1.2.' refers to the test case number, the 'sub test ID' refers to the specific combination of variable parameters in table 4 and the suffix 'h' refers to the velocity of the projectile to set to 105% of the ballistic limit.

## 4 Test Specifications

### 4.1 Test Case Targets

Table 5 displays the test case targets. The test case targets specify values or a series of values taken from the finite element analysis solution of the test case and they are used in a comparison of analysis results and experimental data. They are chosen in a way that they can be directly or indirectly compared to the experimentally determined values or observations.

| Test Case Targets |                |                |              |                    |
|-------------------|----------------|----------------|--------------|--------------------|
| Target number     | output         | component type | component id | retrieved from     |
| 1                 | z-displacement | node           | 6            | binout/nodout file |
| 2                 | kinetic energy | part           | 2            | binout/matsum file |

Table 5: Test Case targets for QA Test Case ID AEROQA-1.2

The target values are chosen to identify whether the projectile penetrates the plate or is stopped by the plate. Target number 1 is the displacement of the center node of the plate in the direction of the projectile. Target number 2 is the kinetic energy of the projectile. The targets are used to evaluate the perforation of the steel plate (see section 4.2).

### 4.2 Pass/Fail Criteria

These are the Pass/Fail criteria used for the Validation of the Test Case ID AEROQA-1.2.

A sub test case with 80% of the ballistic limit passes if all of the following criteria are reached:

- The test case target 1 (z-displacement node 6) does not exceed 1.2 inch.
- The test case target 2 (kinetic energy part 2) is less than 300 in-lb.

Otherwise the Validation fails.

A sub test case with 105% of the ballistic limit passes if all of the following criteria are reached:

- The test case target 1 (z-displacement node 6) exceeds 1.2 inch.
- The test case target 2 (kinetic energy part 2) is greater than 500 in-lb.

Otherwise the Validation fails.

## 5 Test Case Results

### 5.1 Software and Hardware Specifications

In order to ensure cross-platform consistency, the herein mentioned sub test cases are run on platforms specified in table 6 and the results are calculated with software versions defined in table 7.

| Platform Name | Operating system | CPU type  | MPI-Protocol | Number of cpu's <sup>1</sup> |
|---------------|------------------|---|--------------|------------------------------|
| sandwich      | SUSE LES 11.1    | Intel <sup>®</sup> Xeon <sup>®</sup> E7- 8837 @ 2.67GHz | hpmmpi       | 4                            |
| ham           | CentOS 5.4       | AMD <sup>®</sup> Opteron <sup>®</sup> 8435 @ 800MHz     | hpmmpi       | 4                            |
| sgi64d        | SUSE LES 9.4     | Intel <sup>®</sup> Itanium <sup>®</sup> 2 @ 1.6GHz      | hpmmpi       | 4                            |

<sup>1</sup> Number of cpu's used for calculation of the test case

Table 6: Used Platforms and CPU Type's

| Product              | Version | Release | Revision | Parallel type <sup>1</sup> | Precision <sup>2</sup> | executable        |
|----------------------|---------|---------|----------|----------------------------|------------------------|-------------------|
| LS-DYNA <sup>®</sup> | 971     | R6.1    | 74159    | SMP                        | SP                     | ls971.74159.R6.1  |
| LS-DYNA <sup>®</sup> | 971     | R6.1    | 74159    | SMP                        | DP                     | ld971.74159.R6.1  |
| LS-DYNA <sup>®</sup> | 971     | R6.1    | 74159    | MPP                        | SP                     | mpp971.74159.R6.1 |
| LS-DYNA <sup>®</sup> | 971     | R6.1    | 74159    | MPP                        | DP                     | mpd971.74159.R6.1 |

<sup>1</sup> MPP = Massively Parallel Processing, SMP = Symmetric Multiprocessing

<sup>2</sup> SP = single precision, DP = double precision

Table 7: Tested LS-DYNA<sup>®</sup> version

## 5.2 Results Summary

Table 8 contains the results of the QA Test Case ID AEROQA-1.2 completed with all combinations of software and hardware defined in section 5.1 (10 \* 2 \* 3 \* 4 total calculation runs). Details on the test results can be found in the section 5.3.

The table 8 validation summary is:

- **PASS** - Pass criteria in section 4.2 is attained.
- **FAILED** - Pass criteria in section 4.2 is not attained.
- **ERROR** - sub test case terminates due to error.
- **N/A** - sub test case was not calculated.

| Sub Test ID | 80% ballistic limit | 105% ballistic limit |
|-------------|---------------------|----------------------|
| 1           | <b>PASS</b>         | <b>PASS</b>          |
| 2           | <b>FAILED</b>       | <b>FAILED</b>        |
| 3           | <b>FAILED</b>       | <b>PASS</b>          |
| 4           | <b>PASS</b>         | <b>FAILED</b>        |
| 5           | <b>N/A</b>          | <b>N/A</b>           |
| 6           | <b>PASS</b>         | <b>PASS</b>          |
| 7           | <b>PASS</b>         | <b>PASS</b>          |
| 8           | <b>PASS</b>         | <b>FAILED</b>        |
| 9           | <b>PASS</b>         | <b>PASS</b>          |
| 10          | <b>PASS</b>         | <b>PASS</b>          |
| 11          | <b>PASS</b>         | <b>PASS</b>          |

Table 8: Validation results summary for QA Test Case ID AEROQA-1.2

### 5.3 Result Details

The following subsections contain detailed results for the QA Test Case ID AEROQA-1.2 for LS-DYNA® R6.1 Revision 74159.

For each sub test case defined in section 3.3 there is a graph displaying the time history of the result target defined in section 4.1 for the platform and software version combinations defined in section 5.1.

The title of the graph states the name of the input deck, the result file name, and the output separated by underscores. The legend contains the result file name, output, platform, and executable. The last number of the legend specifies the number of cpu's used to calculate the example. A leading minus sign refers to the compatibility option for SMP calculations (see [1] for details on this option).

#### Example for title and legend:

*Title:*

'1.2.1.h.k: glstat\_internal\_energy' states that the input deck for sub test case 1 run at 105% of the ballistic limit was used to calculate these results. The component displayed is the internal energy derived from the 'glstat' output file.

*Legend:*

'glstat\_internal\_energy\_sandwich\_ls971.74159.R6.1\_4' states that the graph shows the internal energy derived from the 'glstat' output file for an input deck which was calculated on the 'sandwich' platform with a LS-DYNA® R6.1 Revision 74159 binary (SMP, single precision) on four processors.

### 5.3.1 Test Target 1 (input deck with 105% of the ballistic limit)

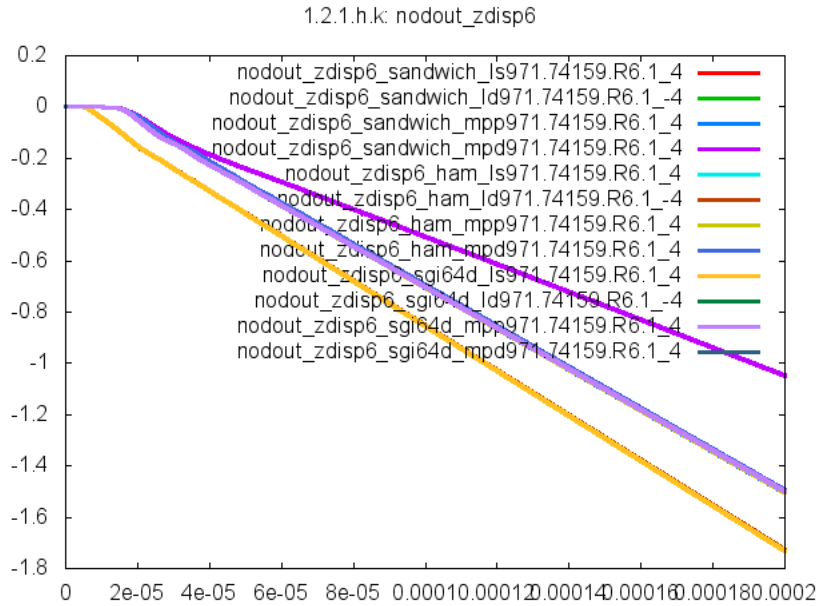

Figure 4: Cross platform results, nodal z displacement node 6, sub test case ID 1, 105% ballistic limit

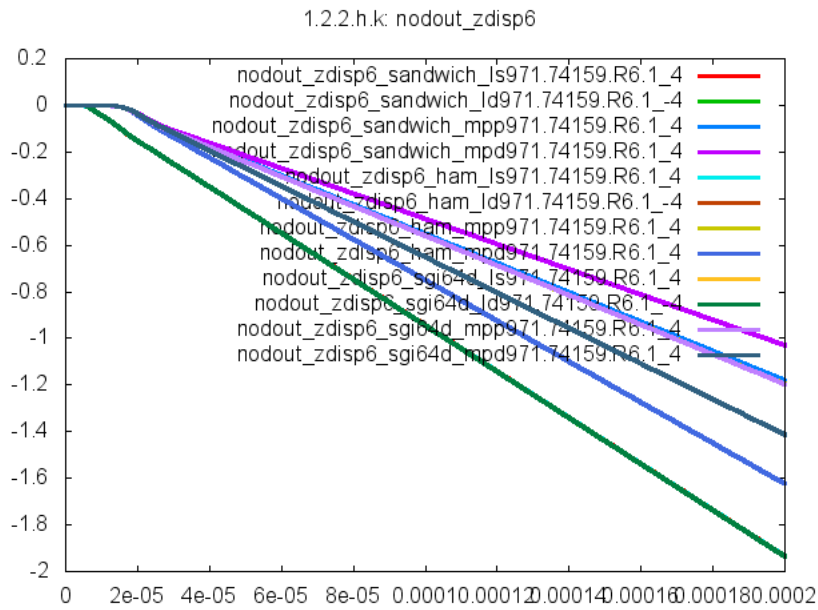

Figure 5: Cross platform results, nodal z displacement node 6, sub test case ID 2, 105% ballistic limit

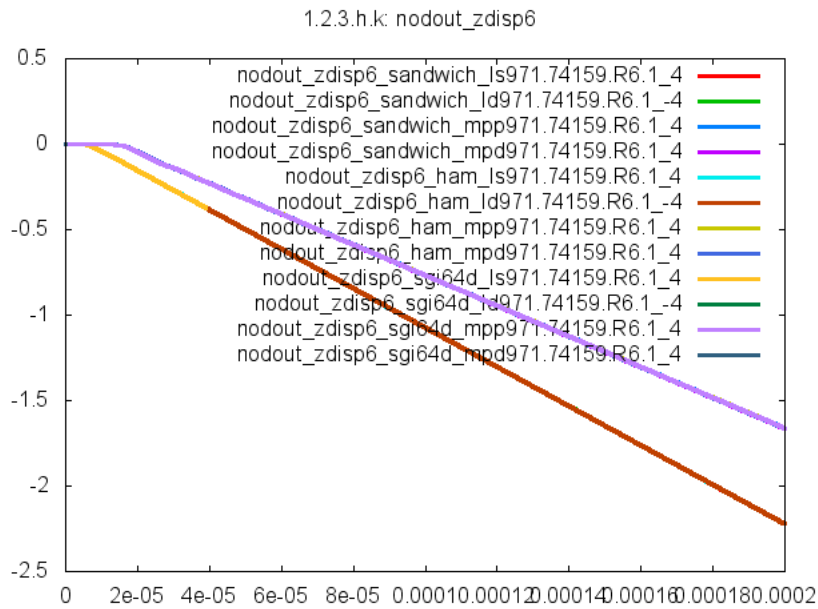

Figure 6: Cross platform results, nodal z displacement node 6, sub test case ID 3, 105% ballistic limit

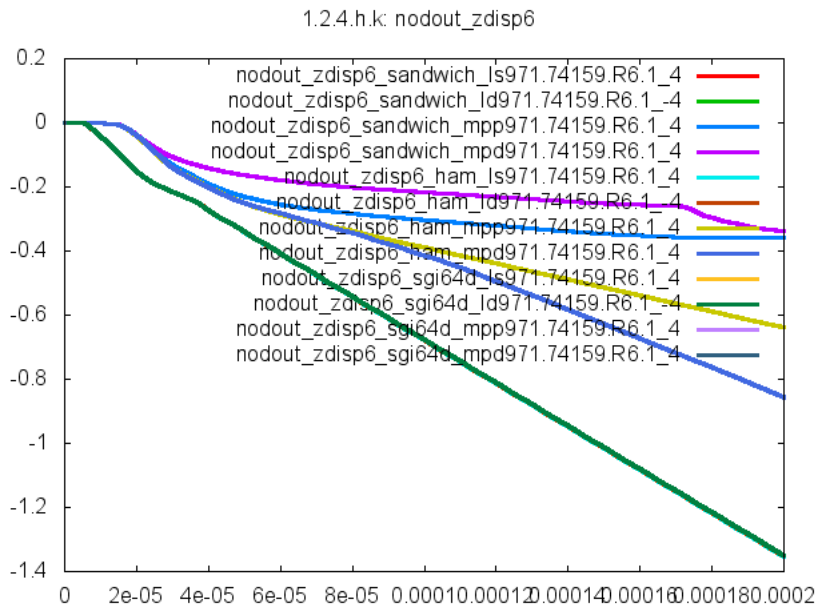

Figure 7: Cross platform results, nodal z displacement node 6, sub test case ID 4, 105% ballistic limit

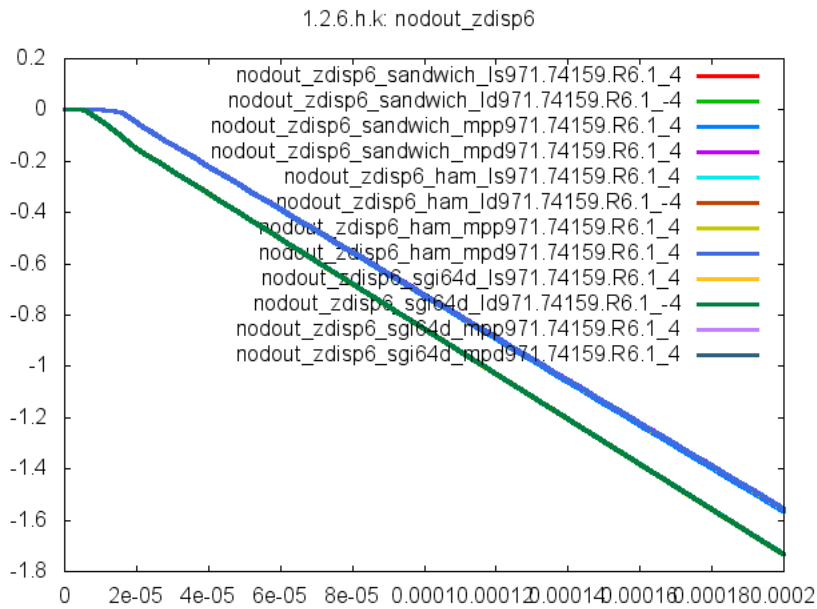

Figure 8: Cross platform results, nodal z displacement node 6, sub test case ID 6, 105% ballistic limit

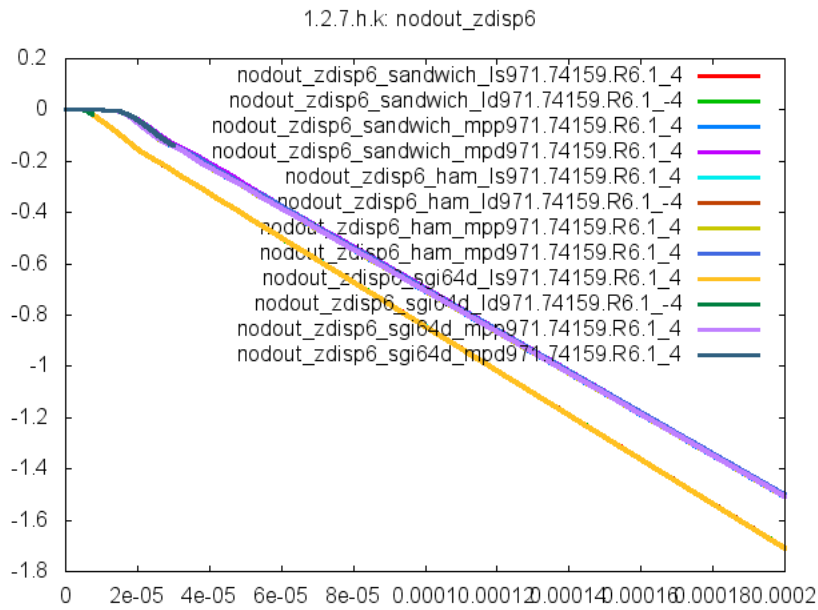

Figure 9: Cross platform results, nodal z displacement node 6, sub test case ID 7, 105% ballistic limit

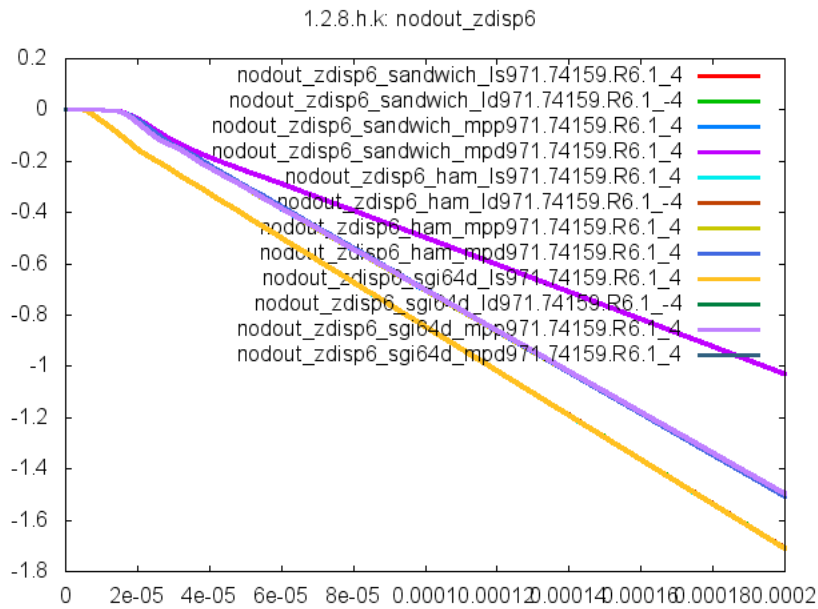

Figure 10: Cross platform results, nodal z displacement node 6, sub test case ID 8, 105% ballistic limit

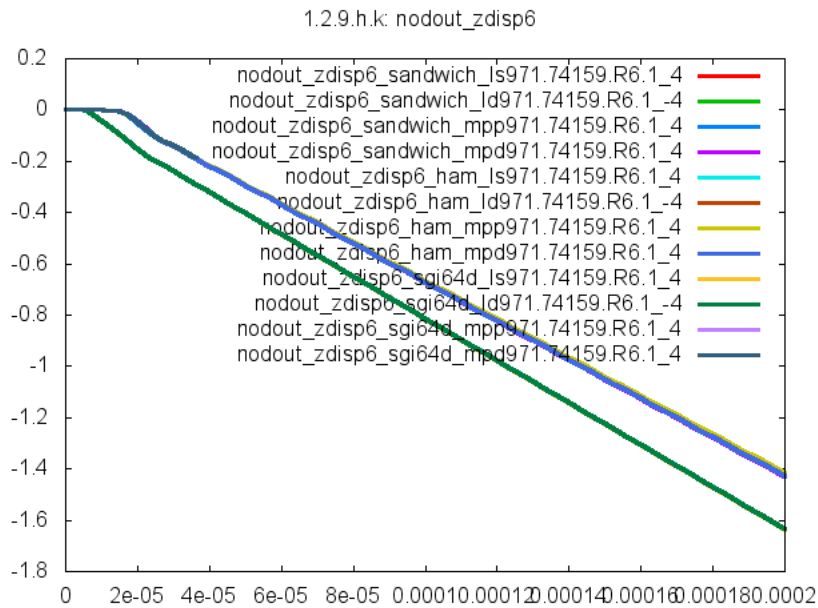

Figure 11: Cross platform results, nodal z displacement node 6, sub test case ID 9, 105% ballistic limit

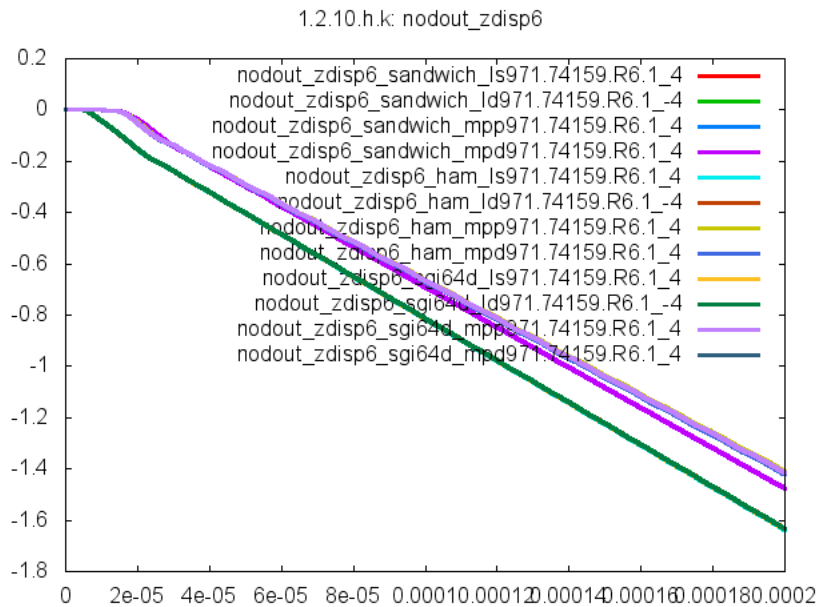

Figure 12: Cross platform results, nodal z displacement node 6, sub test case ID 10, 105% ballistic limit

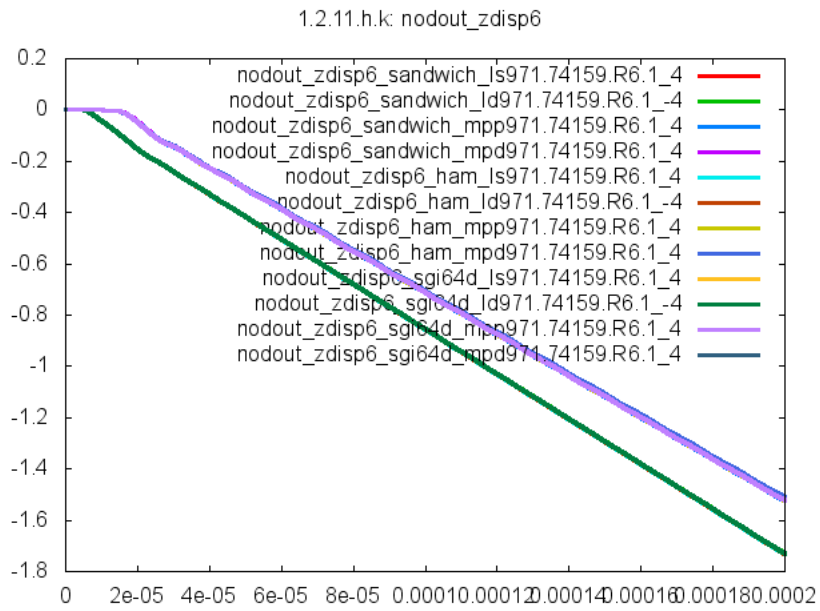

Figure 13: Cross platform results, nodal z displacement node 6, sub test case ID 11, 105% ballistic limit

### 5.3.2 Test Target 1 (input deck with 80% of the ballistic limit)

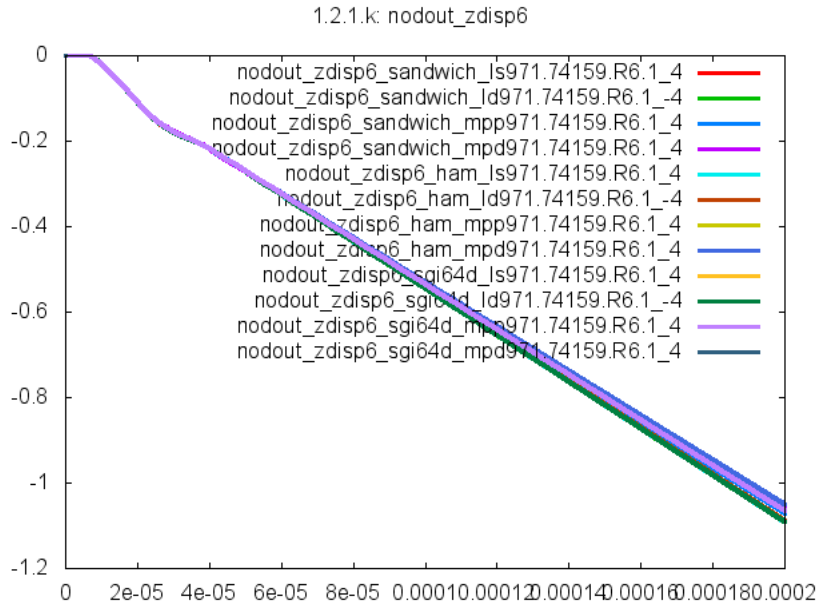

Figure 14: Cross platform results, nodal z displacement node 6, sub test case ID 1, 80% ballistic limit

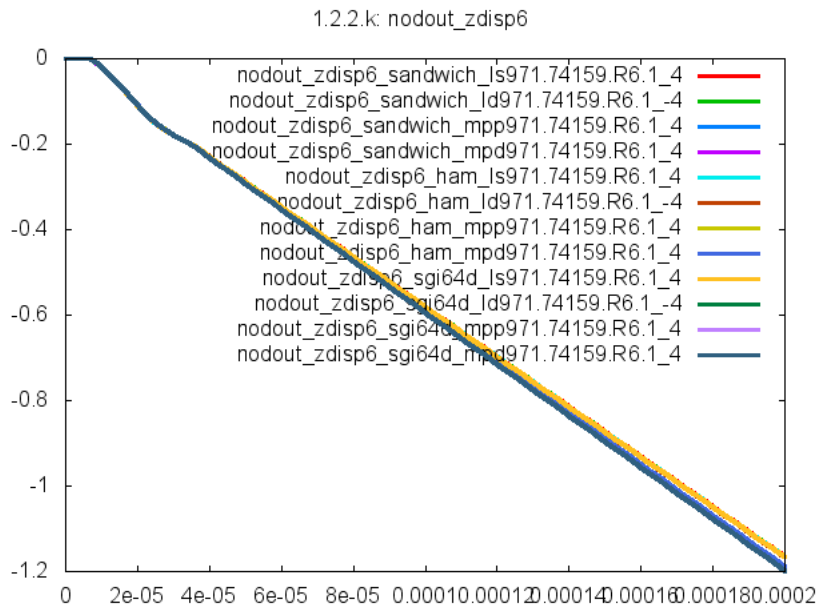

Figure 15: Cross platform results, nodal z displacement node 6, sub test case ID 2, 80% ballistic limit

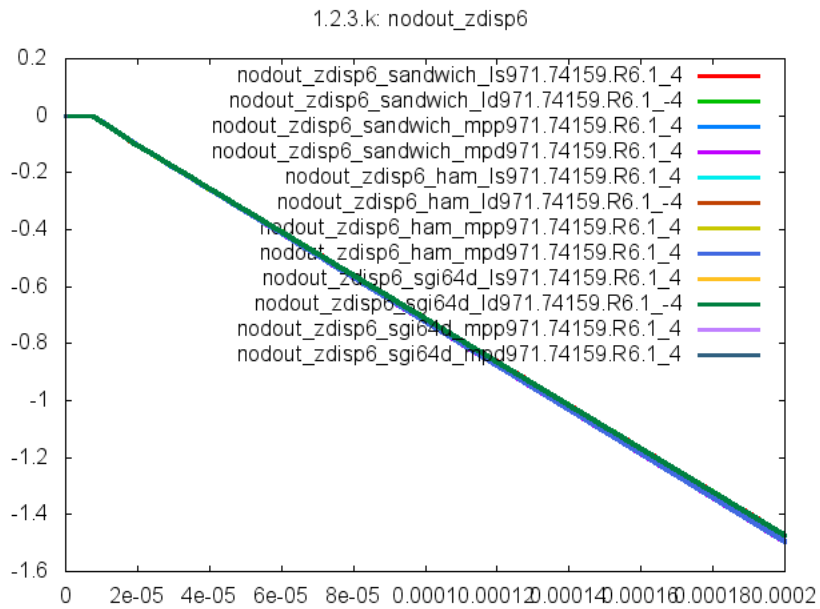

Figure 16: Cross platform results, nodal z displacement node 6, sub test case ID 3, 80% ballistic limit

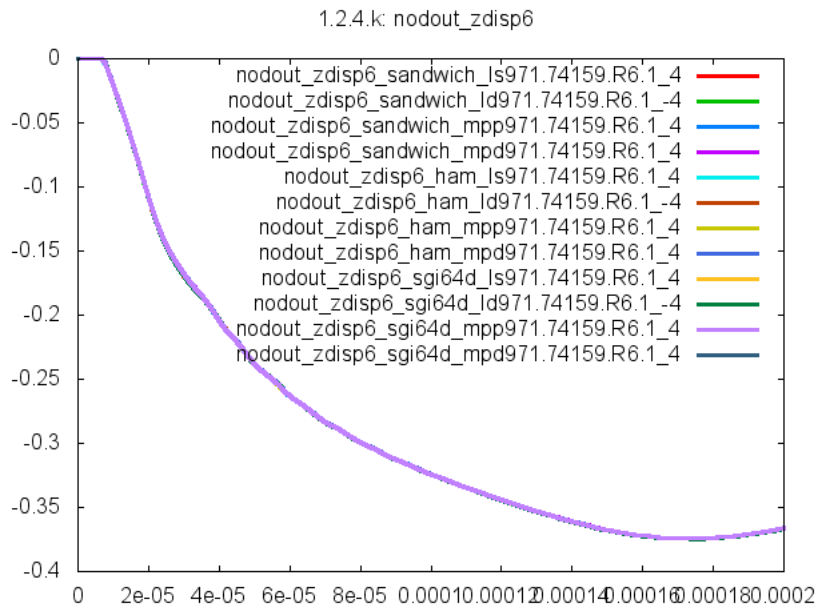

Figure 17: Cross platform results, nodal z displacement node 6, sub test case ID 4, 80% ballistic limit

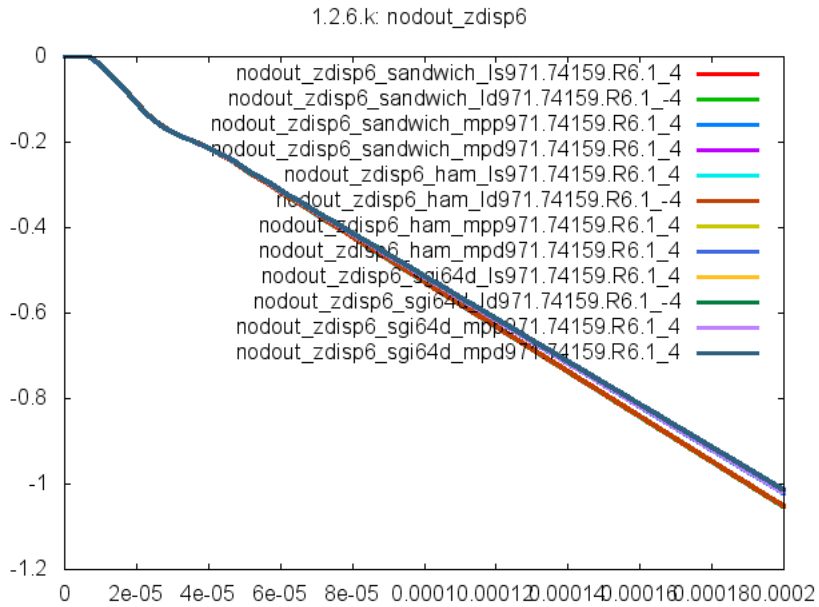

Figure 18: Cross platform results, nodal z displacement node 6, sub test case ID 6, 80% ballistic limit

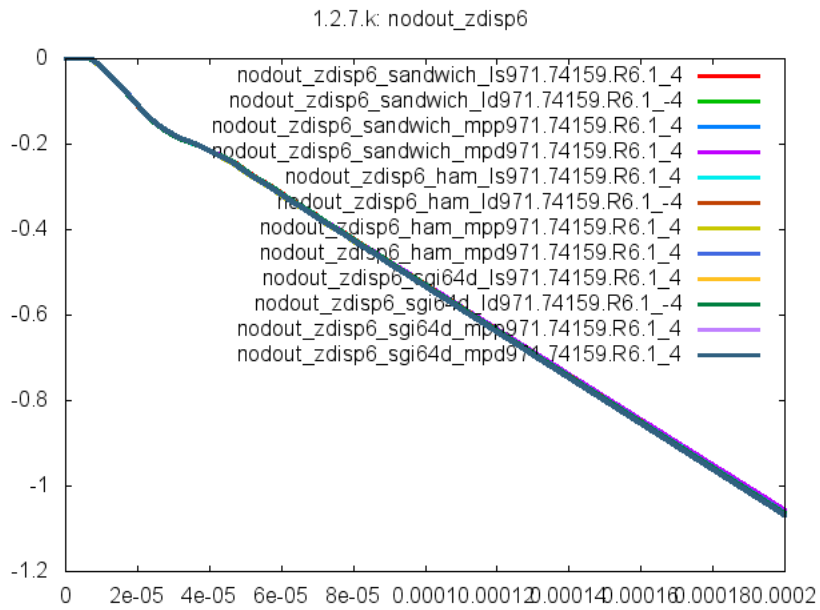

Figure 19: Cross platform results, nodal z displacement node 6, sub test case ID 7, 80% ballistic limit

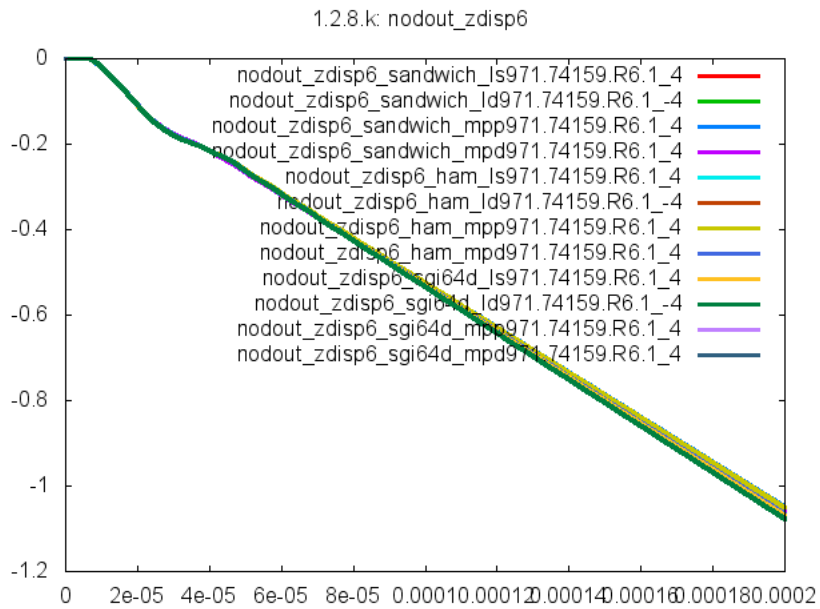

Figure 20: Cross platform results, nodal z displacement node 6, sub test case ID 8, 80% ballistic limit

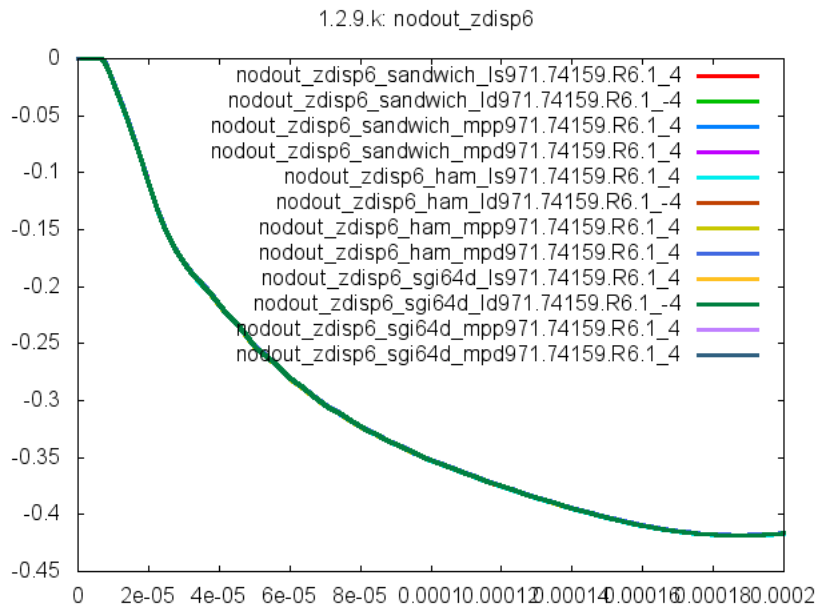

Figure 21: Cross platform results, nodal z displacement node 6, sub test case ID 9, 80% ballistic limit

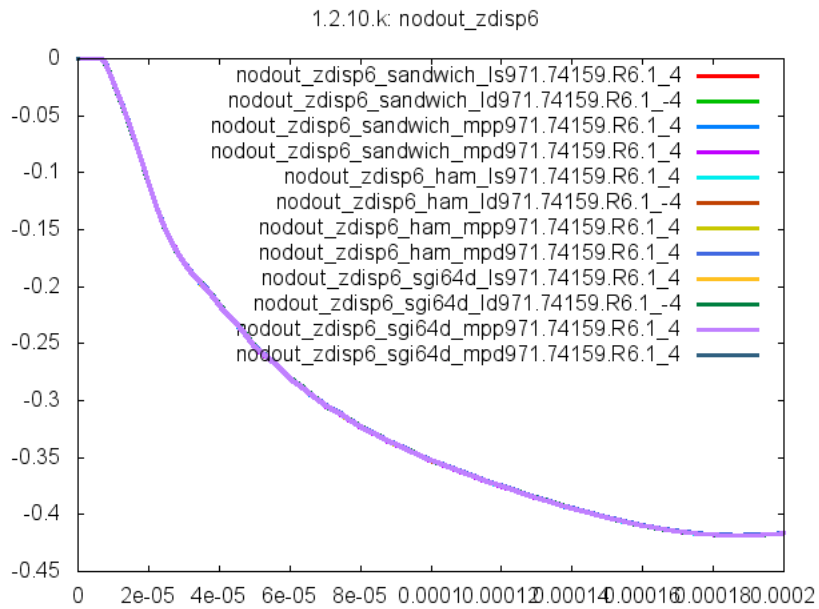

Figure 22: Cross platform results, nodal z displacement node 6, sub test case ID 10, 80% ballistic limit

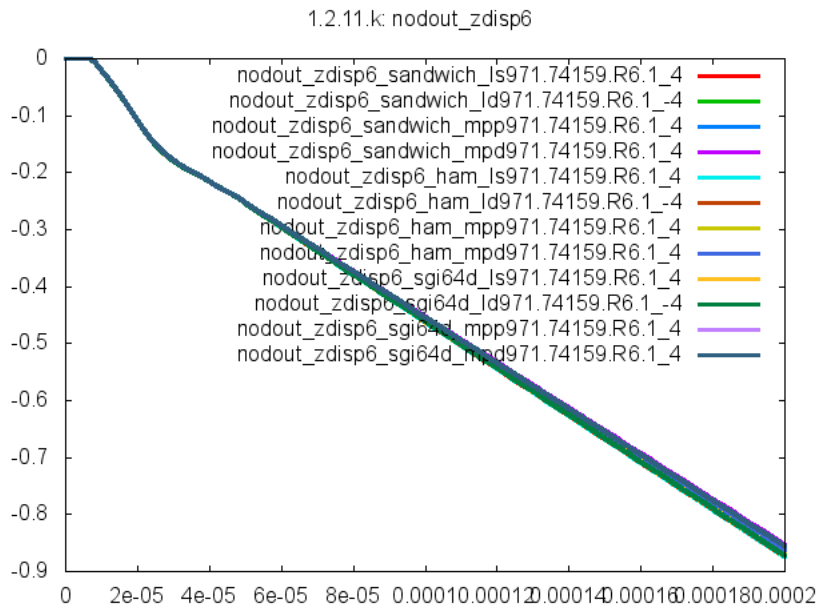

Figure 23: Cross platform results, nodal z displacement node 6, sub test case ID 11, 80% ballistic limit

### 5.3.3 Test Target 2 (input deck with 105% of the ballistic limit)

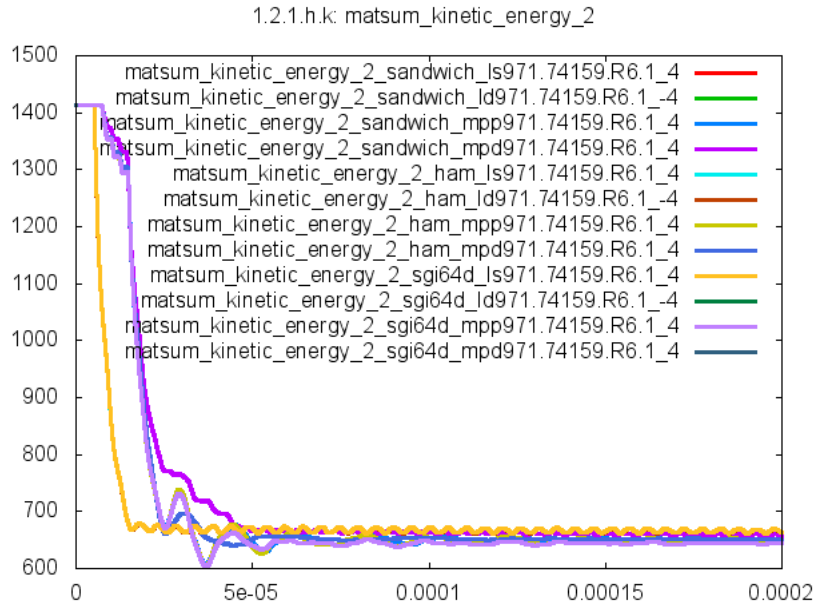

Figure 24: Cross platform results, kinetic energy part 2, sub test case ID 1, 105% ballistic limit

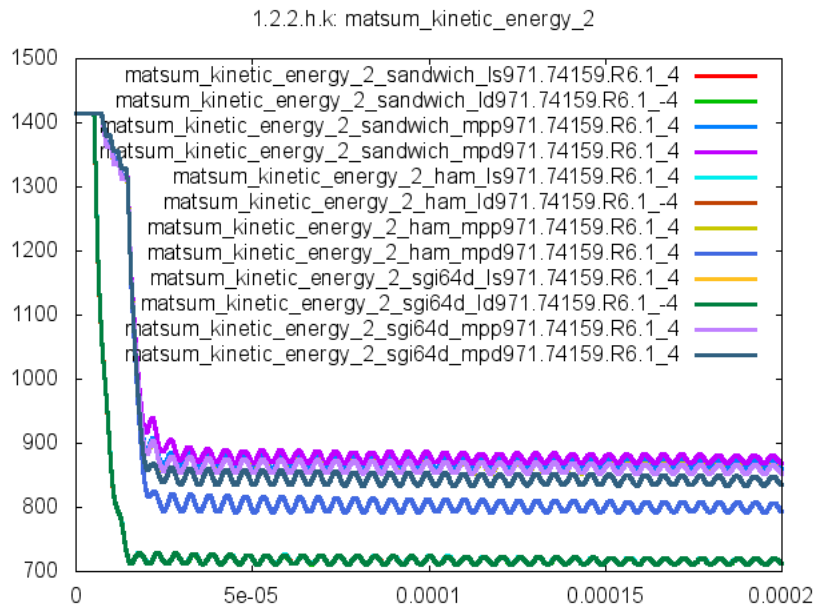

Figure 25: Cross platform results, kinetic energy part 2, sub test case ID 2, 105% ballistic limit

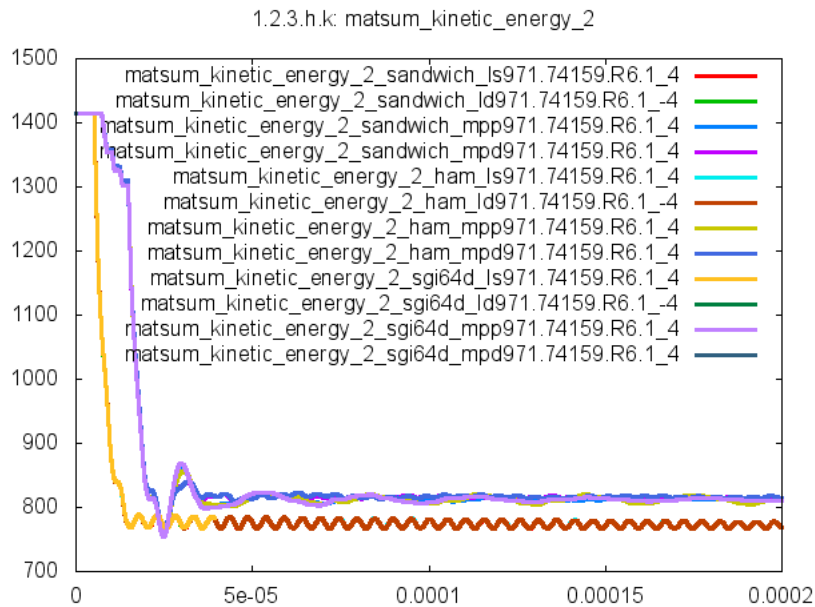

Figure 26: Cross platform results, kinetic energy part 2, sub test case ID 3, 105% ballistic limit

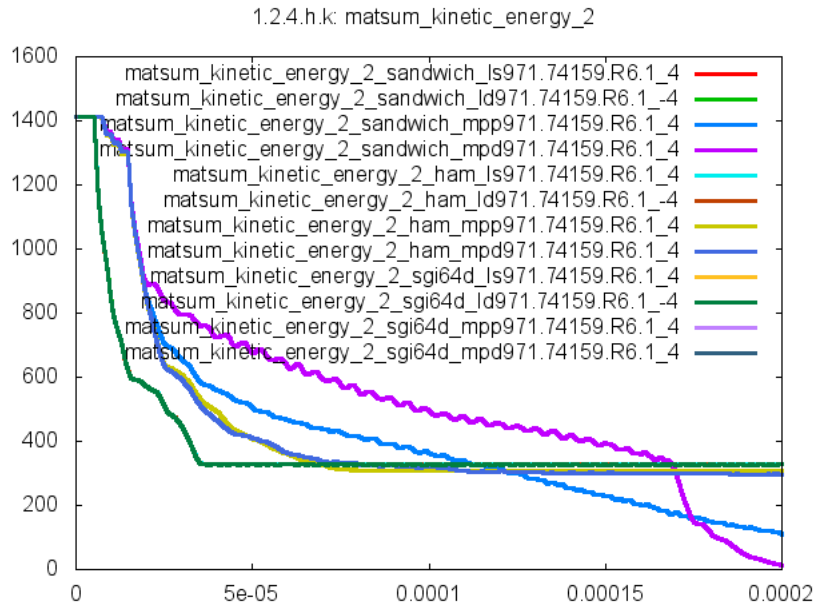

Figure 27: Cross platform results, kinetic energy part 2, sub test case ID 4, 105% ballistic limit

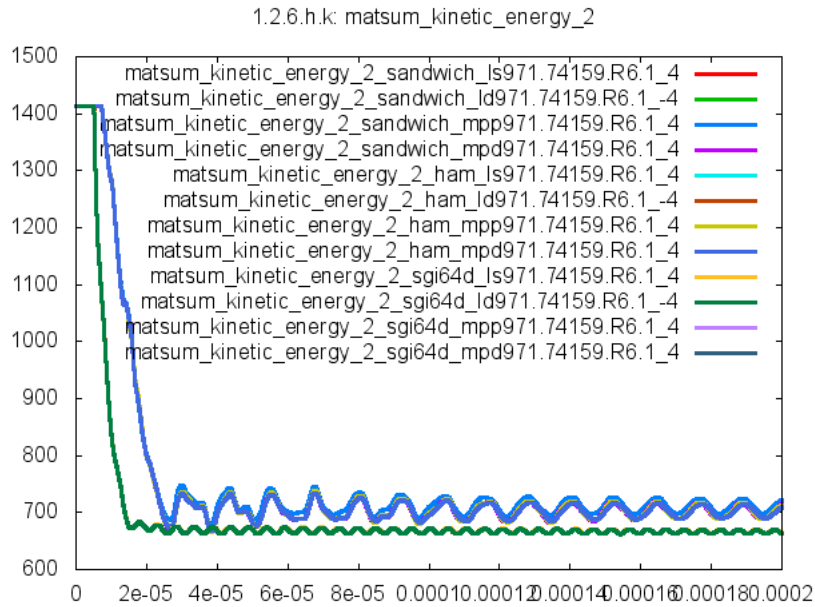

Figure 28: Cross platform results, kinetic energy part 2, sub test case ID 6, 105% ballistic limit

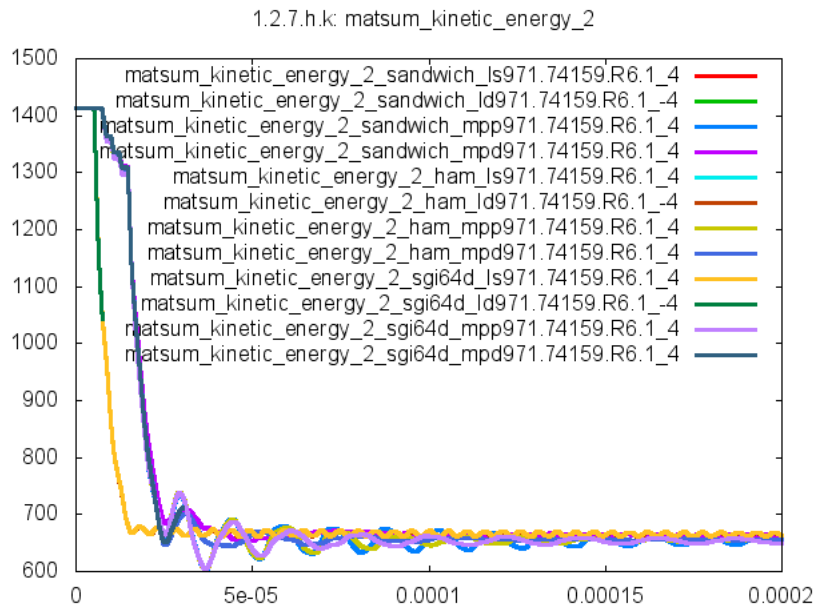

Figure 29: Cross platform results, kinetic energy part 2, sub test case ID 7, 105% ballistic limit

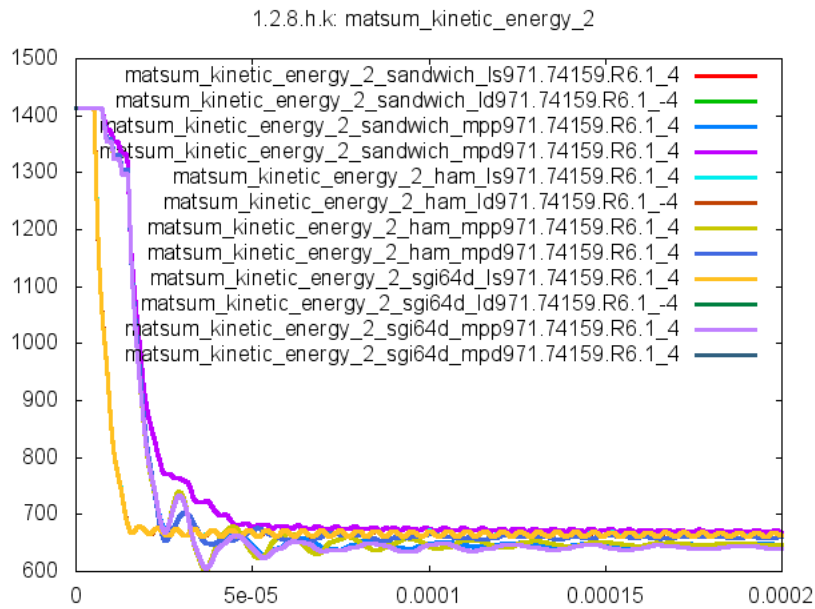

Figure 30: Cross platform results, kinetic energy part 2, sub test case ID 8, 105% ballistic limit

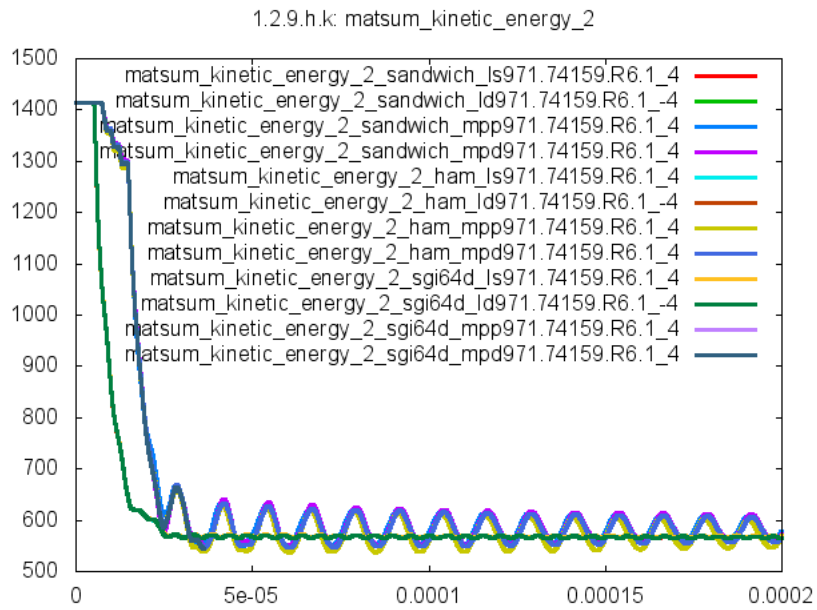

Figure 31: Cross platform results, kinetic energy part 2, sub test case ID 9, 105% ballistic limit

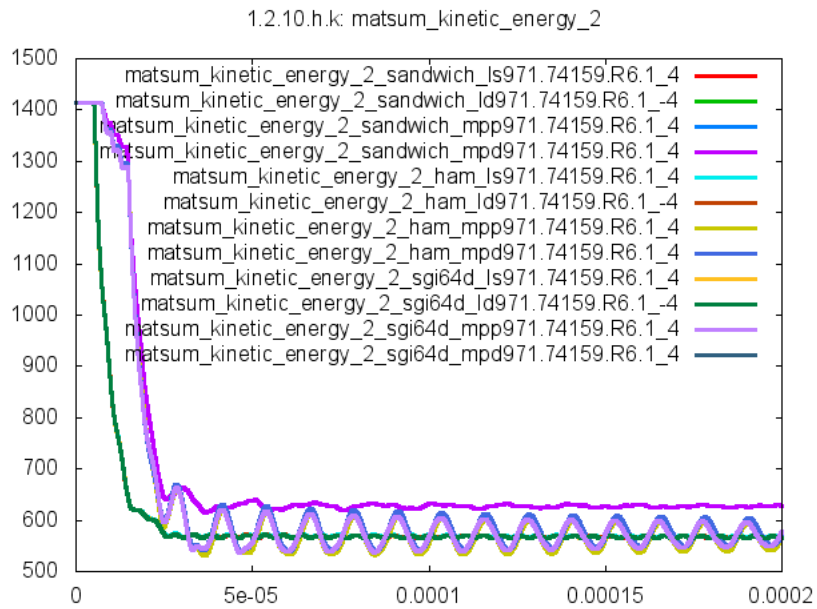

Figure 32: Cross platform results, kinetic energy part 2, sub test case ID 10, 105% ballistic limit

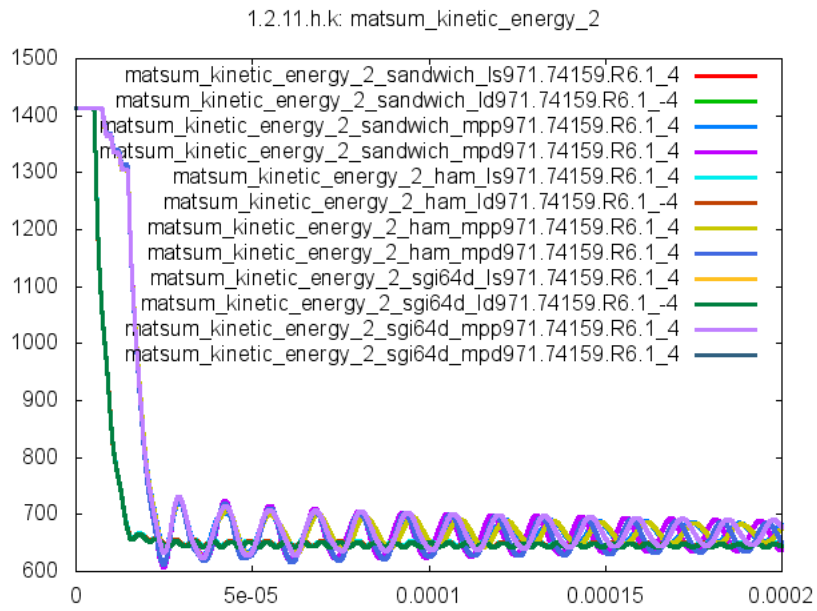

Figure 33: Cross platform results, kinetic energy part 2, sub test case ID 11, 105% ballistic limit

### 5.3.4 Test Target 2 (input deck with 80% of the ballistic limit)

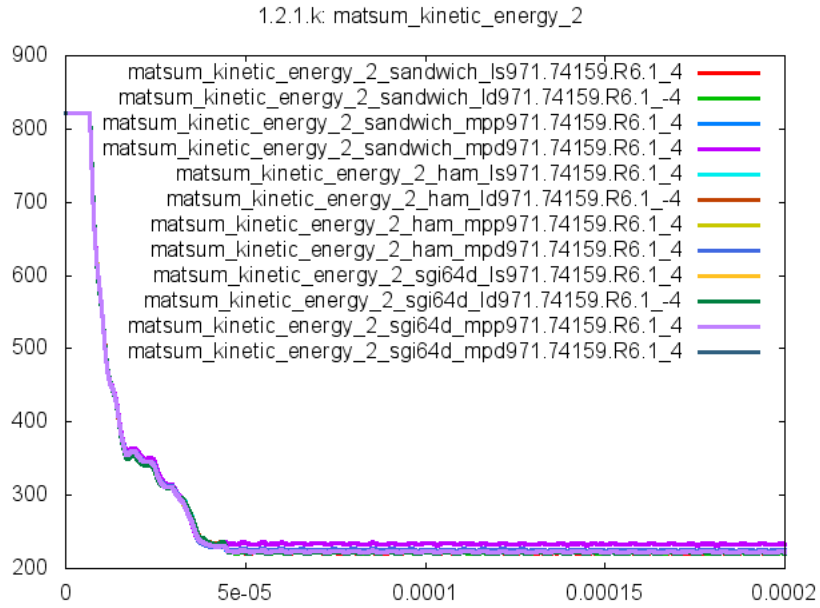

Figure 34: Cross platform results, kinetic energy part 2, sub test case ID 1, 80% ballistic limit

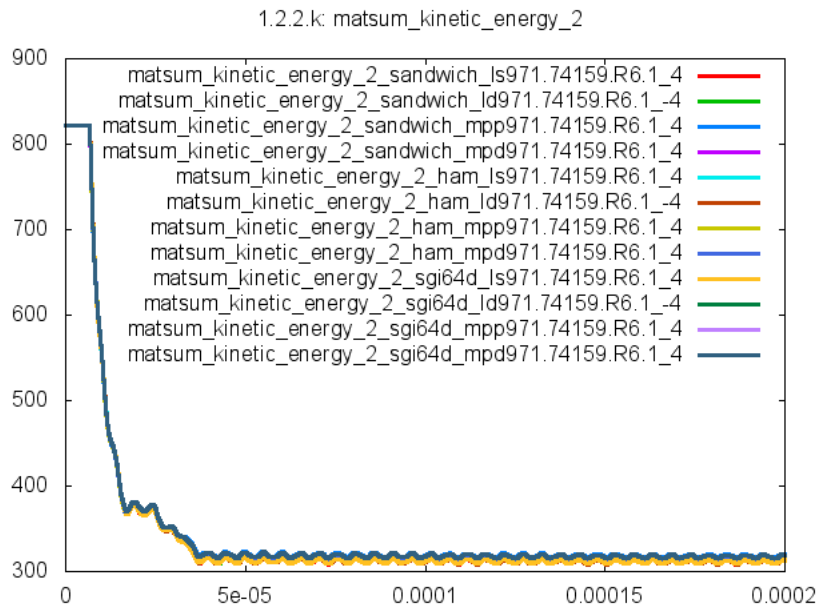

Figure 35: Cross platform results, kinetic energy part 2, sub test case ID 2, 80% ballistic limit

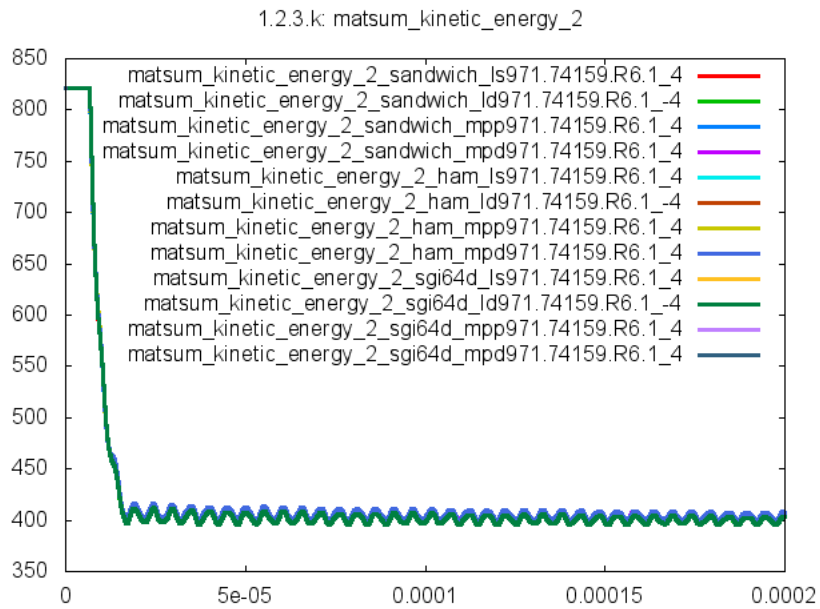

Figure 36: Cross platform results, kinetic energy part 2, sub test case ID 3, 80% ballistic limit

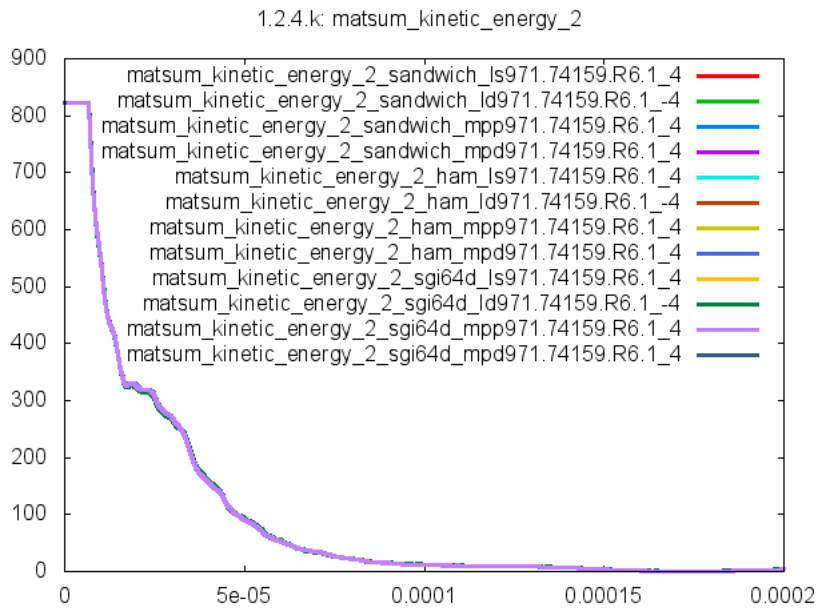

Figure 37: Cross platform results, kinetic energy part 2, sub test case ID 4, 80% ballistic limit

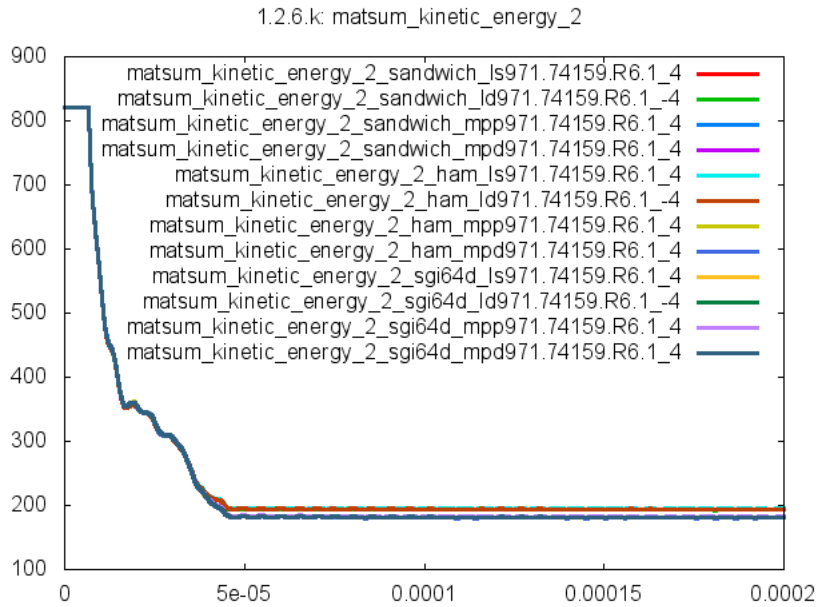

Figure 38: Cross platform results, kinetic energy part 2, sub test case ID 6, 80% ballistic limit

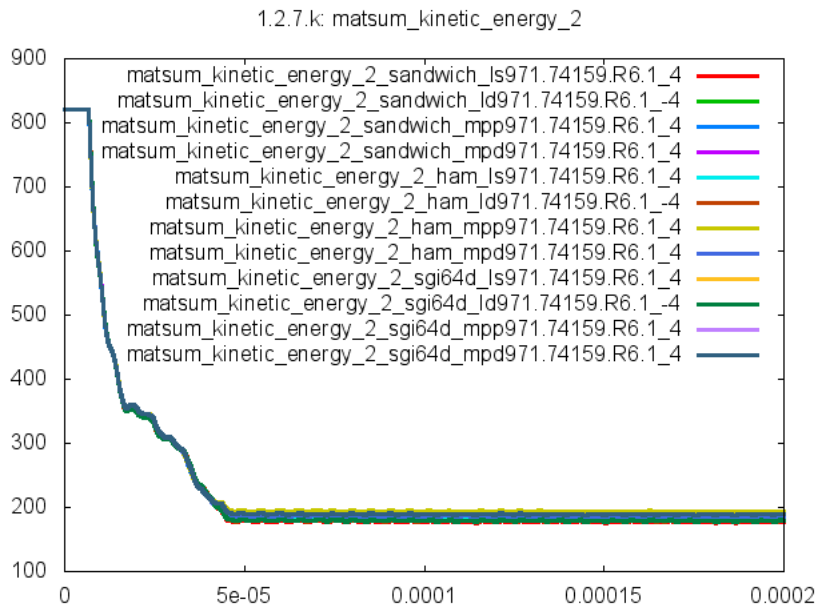

Figure 39: Cross platform results, kinetic energy part 2, sub test case ID 7, 80% ballistic limit

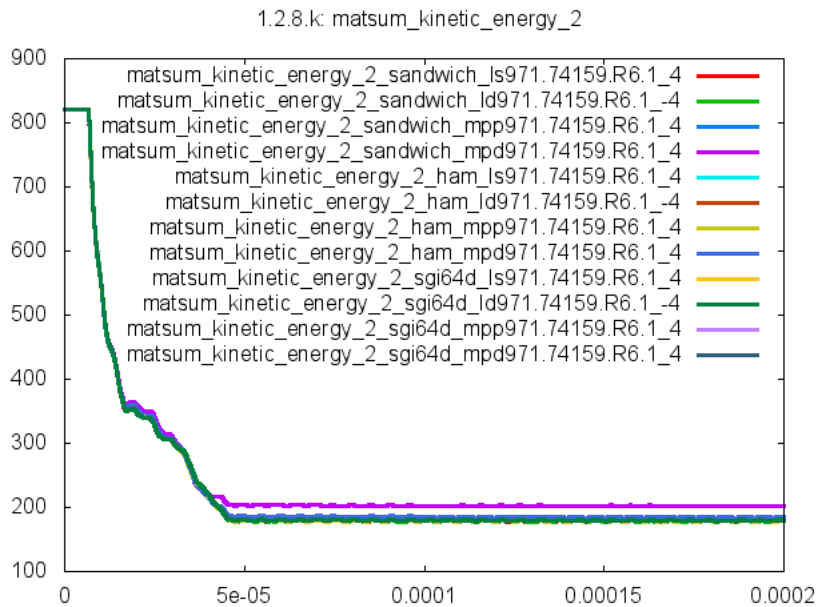

Figure 40: Cross platform results, kinetic energy part 2, sub test case ID 8, 80% ballistic limit

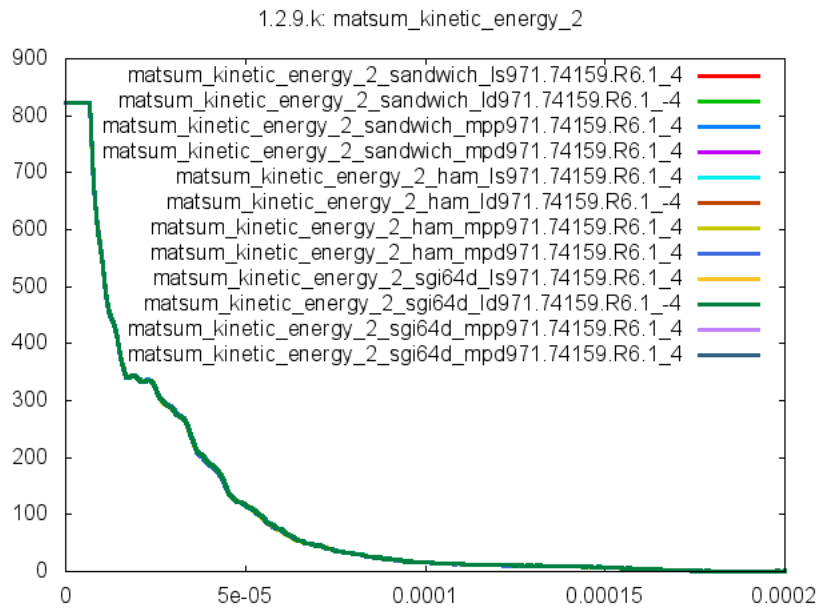

Figure 41: Cross platform results, kinetic energy part 2, sub test case ID 9, 80% ballistic limit

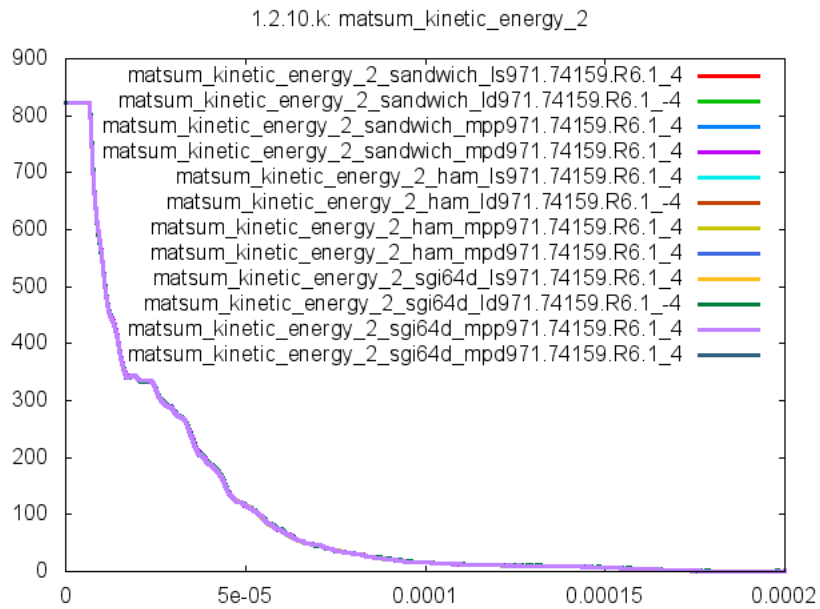

Figure 42: Cross platform results, kinetic energy part 2, sub test case ID 10, 80% ballistic limit

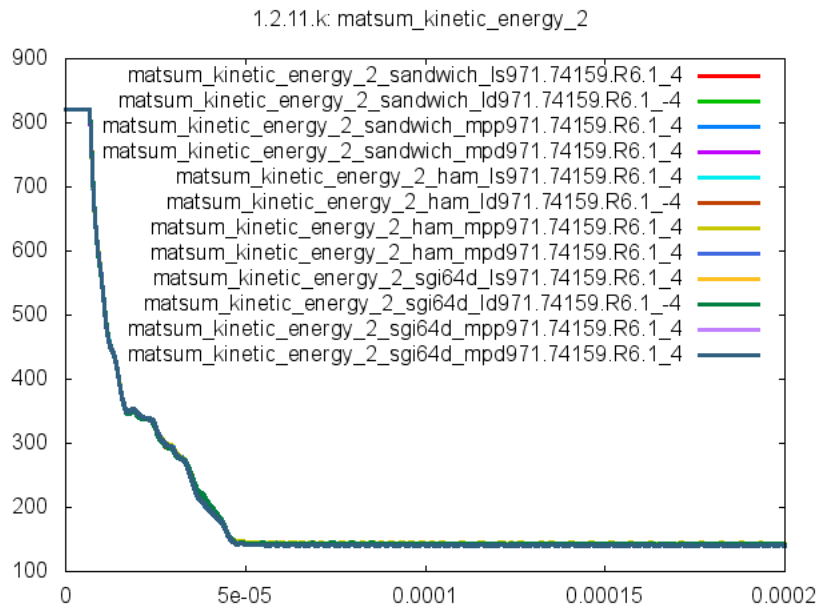

Figure 43: Cross platform results, kinetic energy part 2, sub test case ID 11, 80% ballistic limit

## References

- [1] LSTC, *LS-DYNA KEYWORD USER MANUAL*, 7374 Las Positas Road, Livermore, CA, 94551, USA, version 971 ed., May 2007.